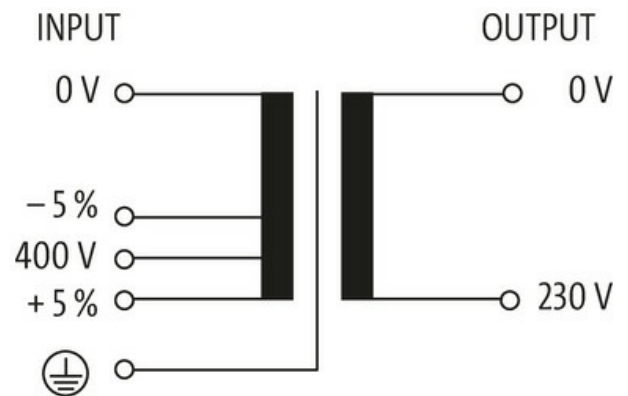

MET 1-PHASE CONTROL AND ISOLATION TRANSFORMER

P: 4000VA IN: 400VAC+/- 5% OUT: 230VAC

Single-phase - Control and Isolation Transformers
 4000 VA
 Spring clamp terminals
 Isolation class T 40/B

[Link to Product](#)**Illustration**

Product may differ from Image

**General data**

Standards	EN 61558-1, EN 61558-2-4, EN 62041 category 0
Mounting method	Long-hole mounting
Temperature range	-20...+40 °C (storage temperature -40...+80 °C)
Test isolation voltage	4 kV (prim./sec.)
Drill hole Ø	9×14 mm
Fixing centers a×b×c	200×174×9 mm
Dimensions H×W×D	206×198×250 mm

The information in this brochure has been compiled with the utmost care.
 Liability for the correctness completeness and topicality of the information is restricted to gross negligence. Version: 03/22

Murrelektronik Ltd. | 5 Albion Street, Pendlebury Industrial Estate, Swinton | Manchester M27 4FG | Fon +44 161 728 3133 | Fax +44 161 728 3130 | shop@murrelektronik.co.uk | shop.murrelektronik.co.uk

Output	
Output voltage	230 V AC
Output rating	4000 VA
Input	
Input voltage	400 V AC \pm 5%
Inrush current	186.7 A (400 V AC)
Short-circuit current	480.8 A (400 V AC)
Input current	10.32 A (400 V AC)
Frequency	50...60 Hz
Commercial data	
country of origin	CZ
customs tariff number	85043200
EAN	4048879066273
eClass	27031302
Packaging unit	1.000