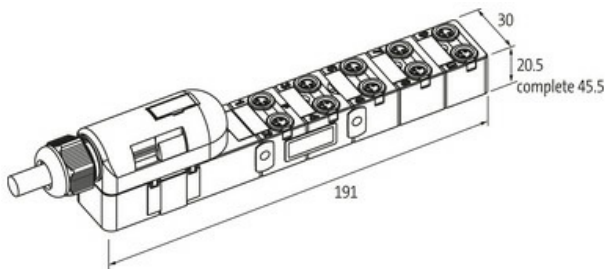
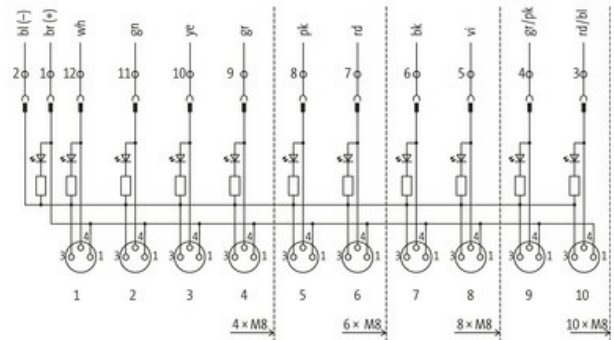

EXACT8, 10XM8, 3 POLE PLUG. CAP, SPRING-TERM.

15.0m PUR 10*0,34+2*0,75 exit norm..

15.0 m

[Link to Product](#)**Illustration**

M8-Females 3-pole

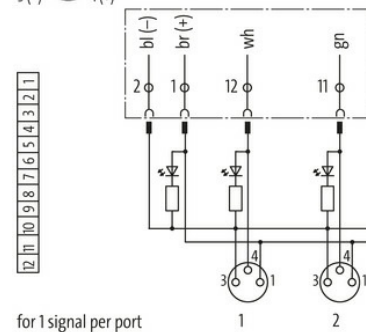

for 1 signal per port

Product may differ from Image

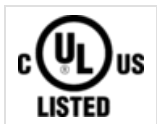
**Form**

Form 80040

Technical Data

Operating voltage	24 V DC
Operating current per contact	max. 2 A
Locking of ports	Screw thread (M8x1 mm)
Connection	Spring clamp plug-in terminals: max. 1.5 mm ² (AWG 16)
Protection	IP67 inserted and tightened (EN 60529)
Housing	Plastic, flame retardant
Signal per port	1 - (31-32)
Total current	max. 8 A

General data

Temperature range -20...+80 °C, depending on cable quality

Cables

No./diameter of wires	10× 0.34 + 2× 0.75 mm ²
C-track properties	5 Mio.
Outer Ø	9.3 mm ±5%
Cable number	384
Approval (cable)	UL (AWM-Style 20233), CSA
Color (jacket)	gray
Jacket Color	gray
Temperature range (fixed)	-40...+80 °C
Temperature range (mobile)	-5...+60 °C
Bend radius (fixed)	5× outer Ø
Bend radius (moving)	10× outer Ø
Material (jacket)	PUR (UL/CSA)

Contact Layout

PIN 1	(+)
PIN 3	(-)
PIN 4	(NO)/(S1)
	LED (green): Power / LED (yellow): (S1)

Commercial data

country of origin	CZ
customs tariff number	85444290
EAN	4048879056861
eClass	27279219
Packaging unit	1.000