

M12 male 90° A-cod. with cable

TPE 4x18AWG ye UL/CSA. ITC/PLTC 2m

Male 90°

M12, 4-pole

USA

Plastic housings with good resistance against chemicals and oils.

The resistance to aggressive media should be individually tested for your application. Further details on request.

Further cable lengths on request.

Cable is approved for 600 V

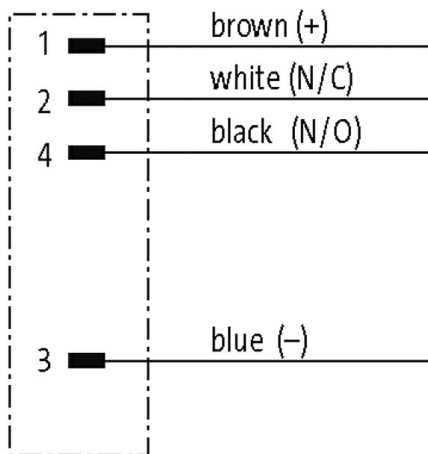
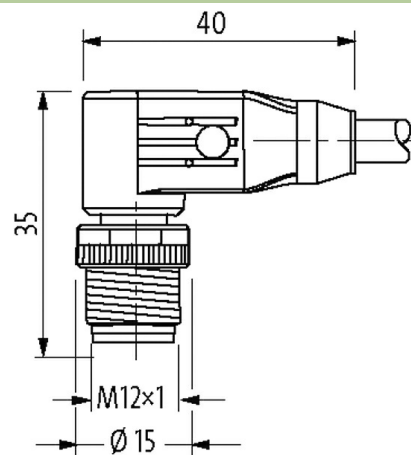
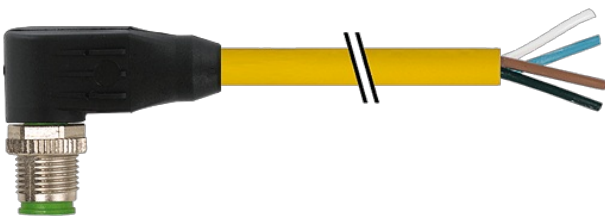
[Link to Product](#)**Illustration**

Male



Product may differ from Image



* only for products with UL/CSA approved cable

Form

Form 12101

Technical Data

Operating voltage max. 250 V AC/DC

Operating voltage (only UL listed)	max. 30 V AC/DC
Rated surge voltage	2.5 kV
Operating current per contact	max. 4 A
Material group	IEC 60664-1, category I
No. of poles	4
Coding	A-coded
Locking of ports	Screw thread (M12×1 mm) recommended torque 0.6 Nm, self-securing
Compression gland	M12 (SW13)
Protection	IP65, IP66K, IP67 inserted and tightened (EN 60529)
Locking material	Zinc die casting, matte nickel plated
suitable for corrugated tube (internal Ø)	without

General data

Standards	DIN EN 61076-2-101 (M12)
Mounting method	inserted, tightened
Pollution Degree	3
Stripping length (jacket)	20 mm
Temperature range	-25...+85 °C, depending on cable quality

Cables

No./diameter of wires	4× 0.75 mm ²
Wire isolation	PVC (br, wh, bl, bk)
C-track properties	10 Mio.
Material (jacket)	TPE (UL/CSA)
Outer Ø	7.2 mm ±5%
Bend radius (moving)	15× outer Ø
Temperature range (fixed)	-40...+105 °C
Temperature range (mobile)	-20...+90 °C
Cable identification	150
Cable Type	TPE
Approval (cable)	UL (AWM-Style 20626/10708), CSA; CE conform
Cable weight [g/m]	78,57
Material (wire)	Cu wire, bare
Resistor (core)	max. 22.5 Ω/km (20 °C)
Single wire Ø (core)	0.234 mm
Construction (core)	19× 0.254 mm (multi-strand wire class 5)
Diameter (core)	4× AWG18/19
Material (wire isolation)	PVC
Wire-Ø incl. isolation	1.93 mm ±5%
Color/numbering of wires	br, bk, bl, wh
Stranding combination	4 wires twisted
Shield	no
Material (jacket)	TPE
Outer-Ø (jacket)	7.2 mm ±5%
Color (jacket)	yellow
thermal resistance	flame retardant
Nominal voltage	600 V AC
Test voltage	4000 V
Current load capacity	to DIN VDE 0298-4
Temperature range (fixed)	-40...+105 °C
Temperature range (mobile)	-20...+90 °C
Bend radius (fixed)	10× outer Ø
Bend radius (moving)	15× outer Ø
No. of bending cycles (C-track)	max. 10 Mio. (25 °C)
Torsion stress	±180°/m

No. of torsion cycles	max. 3 Mio. (25 °C)
-----------------------	---------------------

Jacket Color	yellow
--------------	--------

Commercial data

country of origin	DE
-------------------	----

customs tariff number	85444290
-----------------------	----------

EAN	4048879518802
-----	---------------

eClass	27279218
--------	----------

Packaging unit	1
----------------	---