

M8 male 90° A-cod. with cable shielded

PVC 4x0.34 shielded gy UL/CSA 5m

Male 90°

M8, 4-pole

shielded

with cable sleeves

Plastic housings with good resistance against chemicals and oils.

The resistance to aggressive media should be individually tested for your application. Further details on request.

Further cable lengths on request.

[Link to Product](#)

Illustration

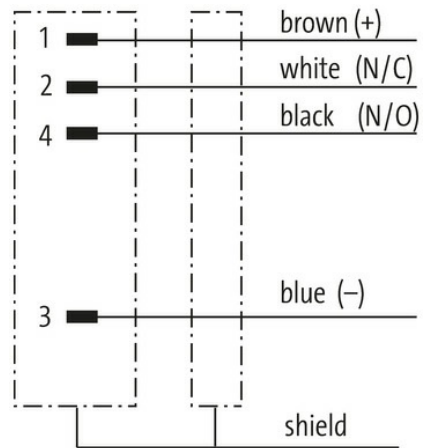
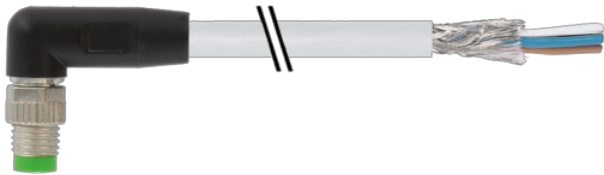

Male

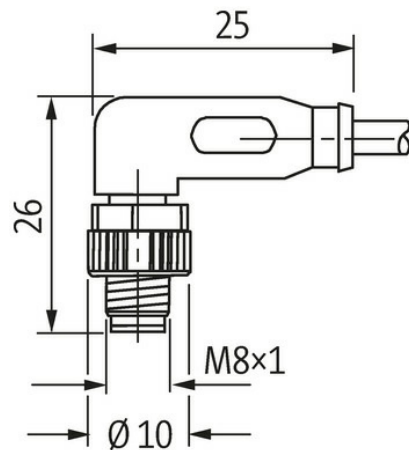
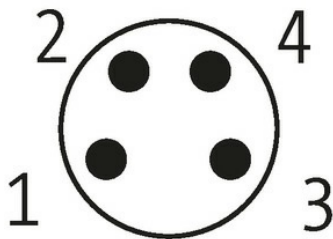

Product may differ from Image



* only for products with UL/CSA approved cable

Form

Form

08731

Technical Data

Operating voltage	max. 50 V AC/60 V DC
Operating voltage (only UL listed)	max. 30 V AC/DC
Rated surge voltage	0.8 kV
Operating current per contact	max. 4 A
Locking of ports	Screw thread (M8×1 mm) recommended torque 0.4 Nm, self-securing
Compression gland	M8 (SW9)
Protection	IP65, IP66K, IP67 inserted and tightened (EN 60529)
suitable for corrugated tube (internal Ø)	6.5 mm

General data

Standards	DIN EN 61076-2-104 (M8)
Temperature range	-25...+85 °C, depending on cable quality

Cables

No./diameter of wires	4× 0.34 mm ²
Wire isolation	PVC (br, wh, bl, bk)
Outer Ø	5.3 mm ±5%
Cable identification	201
Cable Type	1 (PVC)
Approval (cable)	UL (AWM-Style 2464/1731), CSA
Cable weight [g/m]	58,3 g
Material (wire)	Cu wire, bare
Resistor (core)	max. 57 Ω/km (20 °C)
Single wire Ø (core)	0.15 mm
Construction (core)	19× 0.15 mm (multi-strand wire class 5)
Diameter (core)	4× 0.34 mm ²
AWG	similar to AWG 22
Material (wire isolation)	PVC
Material property (wire isolation)	CFC-, cadmium-, silicone- and lead-free
Shore hardness (wire isolation)	45 ±5 D
Wire-Ø incl. isolation	1.25 mm ±5%
Color/numbering of wires	br, bk, bl, wh
Stranding combination	4 wires twisted
Shield	yes
Material (jacket)	PVC
Material property (jacket)	CFC-, cadmium-, silicone- and lead-free
Shore hardness (jacket)	85 ±5 A
Outer-Ø (jacket)	5.3 mm ±5%
Color (jacket)	gray
Jacket Color	gray
Cable print	-
chemical resistance	good resistance to oil, gasoline and chemicals
thermal resistance	flame retardant UL 1581 VW1 / CSA FT1
Nominal voltage	300 V AC
Test voltage	2000 V AC
Current load capacity	to DIN VDE 0298-4
Temperature range (fixed)	-30...+80 °C
Temperature range (fixed)	-30...+80 °C
Temperature range (mobile)	-5...+80 °C
Temperature range (mobile)	-5...+80 °C
Bend radius (fixed)	10× outer Ø
Material (jacket)	PVC (UL/CSA)

Commercial data

country of origin	DE
customs tariff number	85444290

EAN	4048879413299
eClass	27279218
Packaging unit	1.000