

SUPPRESSOR FOR CONTACTORS

VDR, 230 VAC/DC, 200 VA/W

230 V AC/DC

VDR

For other configurations and voltages, please inquire.

[Link to Product](#)

Illustration



VDR

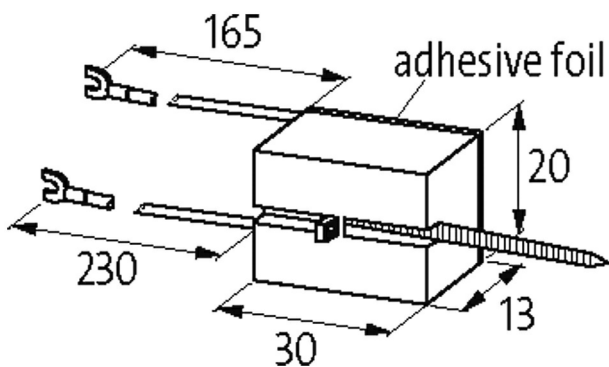

Product may differ from Image



Technical Data

Input voltage	110...300 V AC/DC
Material	Flame retardant plastic acc. to (UL 94)
Damping factor	approx. 1.5× UN
Connection wires	self-securing cable forks
max. power (W)	200 W (VA)

General data

Temperature range	-20...+70 °C
Dimensions H×W×D	30×20×13 mm

Appropriate contactors

The information in this brochure has been compiled with the utmost care. Liability for the correctness completeness and topicality of the information is restricted to gross negligence. Version: 03/22

universal

Commercial data

country of origin	CZ
customs tariff number	85363010
EAN	4048879018128
eClass	27371013
Packaging unit	1.000