

## MOTOR SUPPRESSOR

Varistor, 3x400VAC/4kW

3× 400 V AC

VDR

For DIN-rail mounting use 2×Art.-No. 20900 adapter feet

Suppressors for other voltages, frequencies, and motor ratings available on request. Do not use RC motor suppressors with frequency inverters.

### Link to Product

#### Illustration

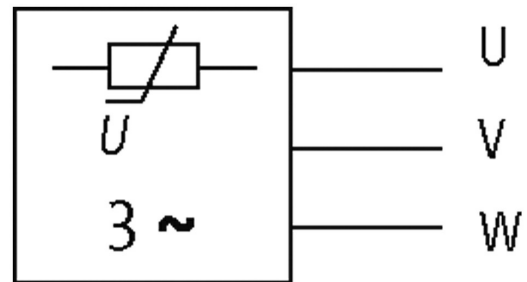

VDR

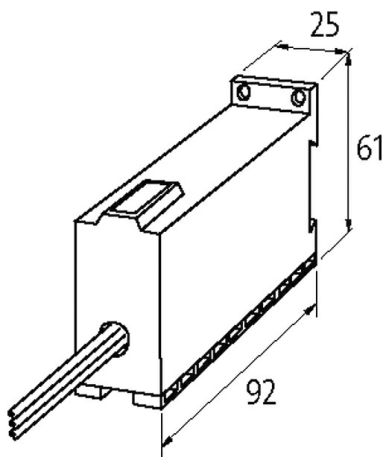

Product may differ from Image

#### Technical Data

Frequency	10...400 Hz
Input voltage	400...400 V AC
Material	Flame retardant plastic acc. to (UL 94)
Potting compound	2-component epoxy

#### General data

Mounting method	DIN-rail mountable TH35 (EN 60715)
Temperature range	-20...+60 °C
Connection	approx. 500 mm, single cores 1 mm <sup>2</sup>
Dimensions H×W×D	92×61×25 mm

**Commercial data**

country of origin	CZ
customs tariff number	85363010
EAN	4048879019385
eClass	27371013
Packaging unit	1.000