

**M12 male 90°/ M12 female 90° B-cod. shielded**

PUR 3x2x0.25 shielded vt 2m

Interbus

Male 90° – female 90°

M12 – M12, 5-pole

shielded

Further cable lengths on request.

Plastic housings with good resistance against chemicals and oils.

The resistance to aggressive media should be individually tested for your application. Further details on request.

[Link to Product](#)

Illustration

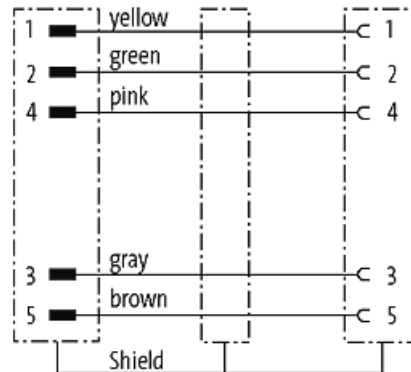
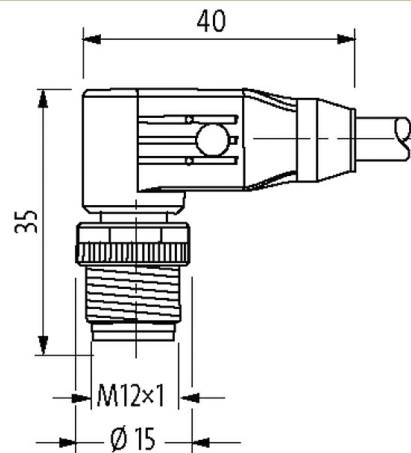
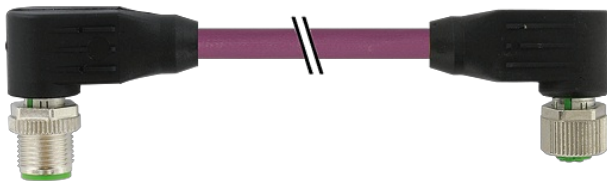

Male

Female

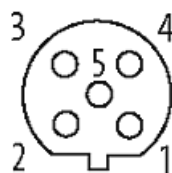

Product may differ from Image



Form	
Form	44061
Technical Data	
Operating voltage	max. 60 V AC/DC
Rated surge voltage	1.5 kV
Operating current per contact	max. 4 A
Material group	IEC 60664-1, category I
No. of poles	5
Coding	B-coded
Locking of ports	Screw thread (M12×1 mm) recommended torque 0.6 Nm, self-securing
Compression gland	M12 (SW13)
Protection	IP65 and IP67 when plugged and screwed down (EN 60529)
Locking material	Zinc die casting, matte nickel plated
General data	
Pollution Degree	3
Temperature range	-25...+85 °C, depending on cable quality
Cables	
No./diameter of wires	3× (2× AWG24)
Wire isolation	PE (whbr, grpk, gnye)
C-track properties	2 Mio.
Material (jacket)	PUR
Outer Ø	7.7 mm ±5%
Bend radius (moving)	15× outer Ø
Temperature range (fixed)	-40...+70 °C
Temperature range (mobile)	-30...+70 °C
Cable identification	799
Approval (cable)	Interbus (DIN 19258/EN50254/IEC 61158 conform)
Cable weight [g/m]	76,49
Material (wire)	Cu wire, bare
Resistor (core)	max. 96 Ω/km (20°C)
Single wire Ø (core)	0.1 mm
Construction (core)	32× 0.1 mm (multi-strand wire class 6)
Diameter (core)	3× (2× AWG24)
AWG	similar to AWG 24
Material (wire isolation)	PE
Shore hardness (wire isolation)	55 ±5 D
Wire-Ø incl. isolation	1.4 mm ±5%
Color/numbering of wires	(wh, br) + (gr, pk) + (gn, ye)
Shield	yes
optical shield cover	min. 85%
Material (jacket)	PUR
Material property (jacket)	CFC-, halogen- and cadmium-free, matt, low-adhesion, machine easy to process, abrasion-resistant
Shore hardness (jacket)	85 ±5 A
Outer-Ø (jacket)	7.7 mm ±5%
Color (jacket)	violet
chemical resistance	good resistance to oil, gasoline and chemicals (VDE 0472 Teil 803/VDE 0249)
Nominal voltage	250 V AC

Test voltage	1500 V (wire/wire); 1000 V (wire/shield)
Temperature range (fixed)	-40...+80 °C
Temperature range (mobile)	-30...+70 °C
Bend radius (fixed)	6× outer Ø
Bend radius (moving)	12× outer Ø
No. of bending cycles (C-track)	max. 2 Mio. (25 °C)
Traversing distance (C-track)	max. 5 m (horizontal)
Travel speed (C-track)	max. 3 m/s
Acceleration (C-track)	max. 3 m/s <sup>2</sup>
Jacket Color	violet

**Commercial data**

country of origin	DE
customs tariff number	85444290
EAN	4048879321501
eClass	27061801
Packaging unit	1