

M12 male 0° / M12 female 0° A-cod. shielded F&B

PVC 0.5+0.25 shielded gy 3m

F&B

The resistance to aggressive media should be individually tested for your application. Further details on request.
Further cable lengths on request.

Cube67

Male straight – female straight

M12 – M12, 6-pole

shielded

A-coded

Stainless steel 1.4404 (V4A)

Hybrid cable

Plastic housings with good resistance against chemicals and oils.

Link to Product

Illustration

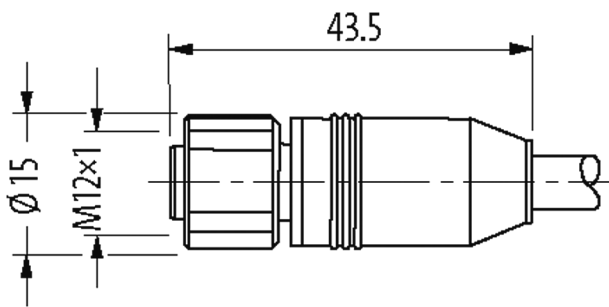
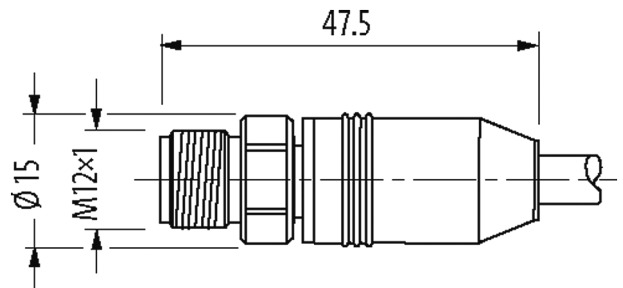

1	■ brown	C 1
2	■ white	C 2
3	■ blue	C 3
4	■ pink	C 4
5	■ gray	C 5
6	■ black	C 6
Shield		

Male

Female

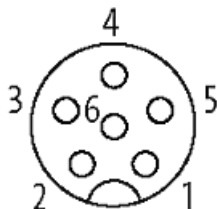
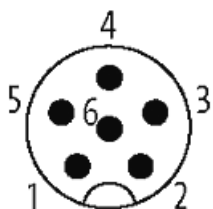

Product may differ from Image



Form	
Form	46041
Technical Data	
Operating voltage	max. 30 V AC/DC
Rated surge voltage	0.8 kV
Operating current per contact	max. 4 A
No. of poles	6
Material group	IEC 60664-1, category I
Coding	A-coded
LED display	no
Locking of ports	Screw thread (M12×1 mm) recommended torque 0.6 Nm, self-securing
Compression gland	M12 (SW14)
Protection	IP65, IP68 inserted and tightened (EN 60529)
Material	PUR
Locking material	Stainless steel 1.4404 (V4A)
General data	
Mounting method	inserted, tightened
Material (contact)	Copper alloy
Material (contact surface)	Au
Material (gasket)	FKM
Pollution Degree	3
Temperature range	-25...+85 °C, depending on cable quality
Cables	
Cable identification	522
Approval (cable)	CE conform
Cable weight [g/m]	104,50
Material (wire)	Cu wire, bare
Resistor (core)	max. 34 Ω/km (20 °C, 0.5 mm ²); max. 75 Ω/km (20 °C, 0.25 mm ²)
Single wire Ø (core)	0.15 mm (0.5 mm ²); 0.1 mm (0.25 mm ²)
Construction (core)	28× 0.15 mm (0.5 mm ²); 32× 0.1 mm (0.25 mm ²); (multi-strand wire class 6)
Diameter (core)	4× 0.5 + 2× 0.25 mm ²
AWG	similar to AWG 20 (0.5 mm ²); similar to AWG 24 (0.25 mm ²)
Material (wire isolation)	TPE-E
Wire-Ø incl. isolation	1.5 mm ±5% (0.5 mm ²); 1.4 mm ±5% (0.25 mm ²)
Color/numbering of wires	(bl, wh, br, bk) + (gr, pk)
Shield	yes
optical shield cover	min. 80%
Material (jacket)	PVC
Outer-Ø (jacket)	7.9 mm ±5%
Color (jacket)	gray
Nominal voltage	500 V AC
Temperature range (fixed)	-30...+90 °C
Temperature range (mobile)	-5...+70 °C
Bend radius (fixed)	5× outer Ø
Bend radius (moving)	10× outer Ø
Traversing distance (C-track)	max. 5 m (horizontal)
Travel speed (C-track)	max. 2 m/s

Acceleration (C-track)	max. 2 m/s ²
Jacket Color	gray
Commercial data	
country of origin	DE
customs tariff number	85444290
EAN	4048879717991
eClass	27061801
Packaging unit	1