

**M12 male 0° A-cod. / MSUD valve plug BI-11mm**

PUR 3x0.75 ye UL/CSA 1.5m

**MSUD**

Form BI (11 mm) – M12, male straight

24 V AC  $\pm 20\%$  / DC  $\pm 25\%$ 

LED and suppression

Further cable lengths on request.

Plastic housings with good resistance against chemicals and oils.

The resistance to aggressive media should be individually tested for your application. Further details on request.

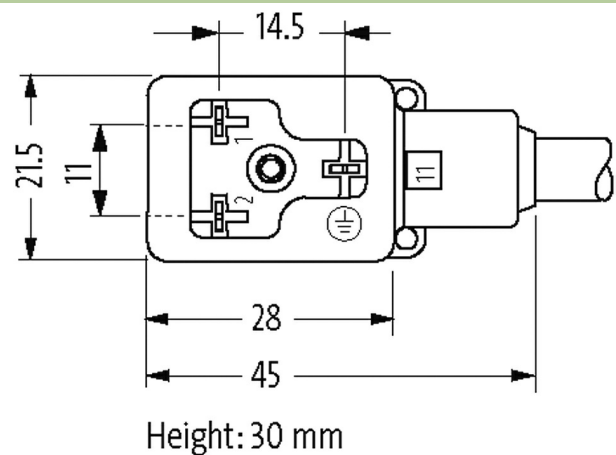
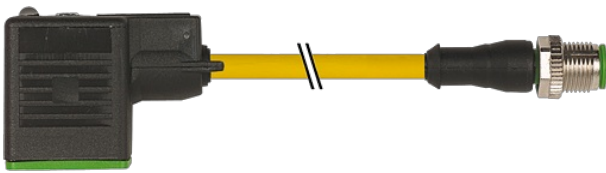
**[Link to Product](#)****Illustration**

Female



Male



Product may differ from Image

\* only for products with UL/CSA approved cable

**Form**

Form

40961

Technical Data	
Operating voltage	24 V AC $\pm 20\%$ / DC $\pm 25\%$
Operating current per contact	max. 4 A
Switch off peak	max. 55 V
Switch off delay time	max. 20 ms
Locking of ports	M3/M12 $\times$ 1 mm (recommended torque 0.4/0.6 Nm)
Housing	Black plastic (gray on request)
Protection	IP67 inserted and tightened (EN 60529)
Rated surge voltage	0.8 kV
General data	
Temperature range	-25...+85 °C, depending on cable quality
Cables	
No./diameter of wires	3 $\times$ 0.75 mm <sup>2</sup>
Wire isolation	PVC (bk num, gnye)
C-track properties	2 Mio.
Material (jacket)	PUR/PVC (UL/CSA)
Outer $\varnothing$	5.9 mm $\pm 5\%$
Bend radius (moving)	15 $\times$ outer $\varnothing$
Temperature range (fixed)	-30...+80 °C
Temperature range (mobile)	-5...+80 °C
Cable identification	026
Cable Type	2 (PUR/PVC)
Approval (cable)	UL (AWM-Style 20549/1731), CSA; CE conform
Cable weight [g/m]	55,00
Material (wire)	Cu wire, bare
Resistor (core)	max. 26 $\Omega$ /km (20 °C)
Single wire $\varnothing$ (core)	0.15 mm
Construction (core)	42 $\times$ 0.15 mm (multi-strand wire class 6)
Diameter (core)	3 $\times$ 0.75 mm <sup>2</sup>
AWG	similar to AWG 18
Material (wire isolation)	PVC
Material property (wire isolation)	CFC-, cadmium-, silicone- and lead-free
Shore hardness (wire isolation)	43 $\pm 5$ D
Wire- $\varnothing$ incl. isolation	1.8 mm $\pm 5\%$
Color/numbering of wires	bk numbered, gnye longitudinally striped
Stranding combination	3 wires twisted
Shield	no
Material (jacket)	PUR/PVC
Material property (jacket)	CFC-, halogen-, cadmium-, silicone- and lead-free, matt, low-adhesion, machine easy to process, abrasion-resistant, hydrolysis and microbial resistant
Shore hardness (jacket)	80 $\pm 5$ A (PVC-under jacket); 85 $\pm 5$ A (PUR-jacket)
Outer- $\varnothing$ (jacket)	5.9 mm $\pm 5\%$
Color (jacket)	yellow
chemical resistance	good resistance to oil, gasoline and chemicals
Nominal voltage	UL 300 V AC
Test voltage	2000 V AC
Current load capacity	to DIN VDE 0298-4
Temperature range (fixed)	-30...+80 °C
Temperature range (mobile)	-5...+80 °C
Bend radius (fixed)	10 $\times$ outer $\varnothing$
Bend radius (moving)	15 $\times$ outer $\varnothing$
No. of bending cycles (C-track)	max. 2 Mio. (25 °C)
Traversing distance (C-track)	max. 5 m (horizontal)
Travel speed (C-track)	max. 3.3 m/s

The information in this brochure has been compiled with the utmost care.

Liability for the correctness completeness and topicality of the information is restricted to gross negligence. Version: 03/22

Acceleration (C-track)	max. 5 m/s <sup>2</sup>
Jacket Color	yellow
<b>Commercial data</b>	
country of origin	CZ
customs tariff number	85444290
EAN	4048879149310
eClass	27279218
Packaging unit	1