

M12 male 0° / M12 male 0° D-cod. shielded

TPE 22AWG SF/UTP CAT5e gn UL/CSA. ITC/PLTC 8m

USA

Ethernet CAT5

The resistance to aggressive media should be individually tested for your application. Further details on request.

Male straight – male straight

M12 – M12, 4-pole

D-coded

shielded

without cable sleeves

Further cable lengths on request.

Plastic housings with good resistance against chemicals and oils.

[Link to Product](#)

Illustration

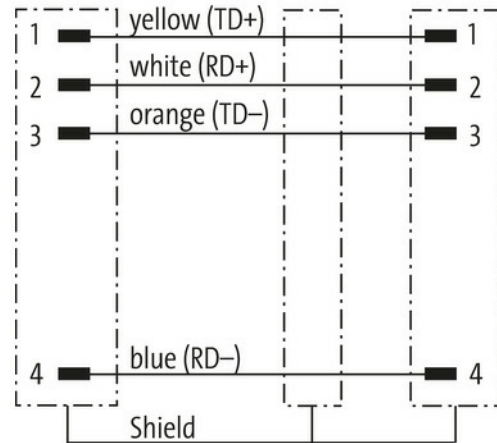

Male

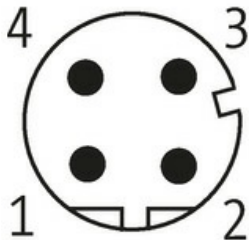

Male



Product may differ from Image

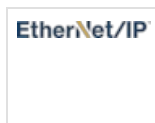
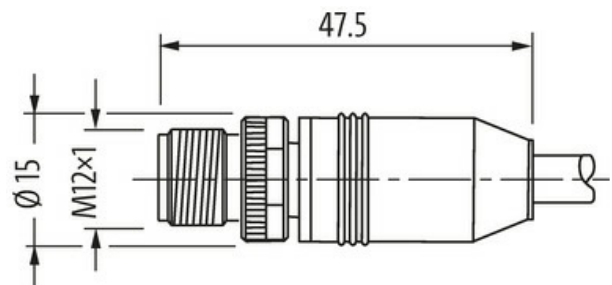

* only for products with UL/CSA approved cable

Form

Form

44511

Technical Data	
Operating voltage	max. 60 V DC
Rated surge voltage	1.5 kV
	1.5 A
No. of poles	4
Transfer parameters	CAT5, Class D (ISO/IEC 11801:2002), (EN 50173-1)
Transfer rate	up to 100 Mbit/s full duplex
Material group	IEC 60664-1, category I
Coding	D-coded
LED display	no
Locking of ports	Screw thread (M12×1 mm) recommended torque 0.6 Nm, self-securing
Compression gland	M12 (SW13)
Protection	IP65, IP66K, IP67 inserted and tightened (EN 60529)
Material	PUR
Locking material	Zinc die casting, matte nickel plated
suitable for corrugated tube (internal Ø)	without
General data	
Standards	DIN EN 61076-2-101 (M12)
Mounting method	inserted, tightened
Pollution Degree	3
Temperature range	-25...+85 °C, depending on cable quality
Cables	
Cable identification	S7V
Cable weight [g/m]	74,8 g
Material (wire)	Cu wire, tin plated
Construction (core)	19× 0.16 mm (multi-strand wire class 5)
Diameter (core)	2× 2× 0.34 mm ²
Material (wire isolation)	HDPE
Wire-Ø incl. isolation	1.42 mm ±5%
Shield	yes
Material (jacket)	TPE
Outer-Ø (jacket)	7.9 mm ±5%
Color (jacket)	green
Temperature range (fixed)	-40...+80 °C
Temperature range (mobile)	-20...+80 °C
Bend radius (fixed)	5× outer Ø
Bend radius (moving)	10× outer Ø
Torsion stress	3 Mio.
Commercial data	
country of origin	DE
customs tariff number	85444290
EAN	4048879649124
eClass	27061801
Packaging unit	1.000