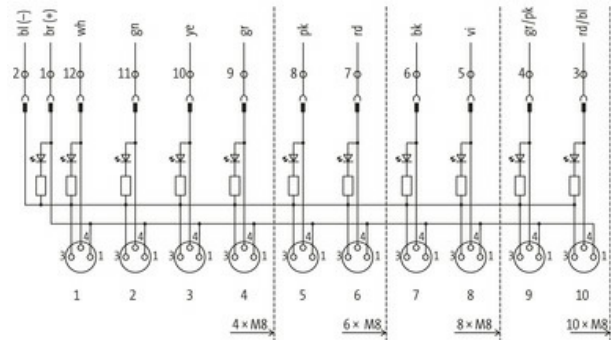
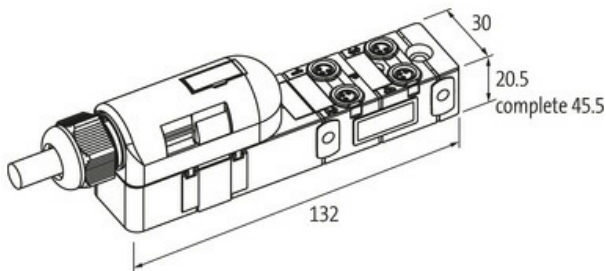

EXACT8, 4XM8, 3 POLE PLUG. CAP, SPRING-TERM.

5.0m PUR 4X0.34+2x0,75, UL/CSA

5.0 m

[Link to Product](#)**Illustration**

M8-Females 3-pole

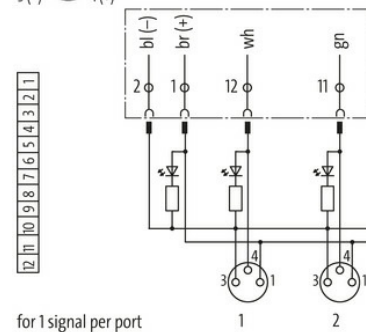

for 1 signal per port

Product may differ from Image

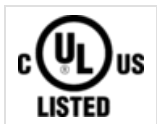
**Form**

Form 84040

Technical Data

Operating voltage	24 V DC
Operating current per contact	max. 2 A
Locking of ports	Screw thread (M8x1 mm)
Connection	Spring clamp plug-in terminals: max. 1.5 mm ² (AWG 16)
Protection	IP67 inserted and tightened (EN 60529)
Housing	Plastic, flame retardant
Total current	max. 8 A

General data

Temperature range -20...+80 °C, depending on cable quality

Cables

No./diameter of wires	4× 0.34 + 2× 0.75 mm ²
Wire isolation	TPE-E
C-track properties	5 Mio.
Outer Ø	7.6 mm ±5%
Cable number	334
Approval (cable)	UL (AWM-Style 20233), CSA
Color (jacket)	gray
Jacket Color	gray
Temperature range (fixed)	-40...+80 °C
Temperature range (mobile)	-5...+60 °C
Bend radius (fixed)	5× outer Ø
Bend radius (moving)	10× outer Ø
Material (jacket)	PUR (UL/CSA)

Contact Layout

PIN 1	(+)
PIN 3	(-)
PIN 4	(NO)/(S1)
	LED (green): Power / LED (yellow): (S1)

Commercial data

country of origin	CZ
customs tariff number	85444290
EAN	4048879056465
eClass	27279219
Packaging unit	1.000