

M12 male 90° A-cod. / MSUD valve plug CI-9.4mm

PVC 3x0.75 gy 0.6m

Form CI (9.4 mm) – M12, male 90°

24 V AC $\pm 20\%$ / DC $\pm 25\%$

LED and suppression

Further cable lengths on request.

Plastic housings with good resistance against chemicals and oils.

The resistance to aggressive media should be individually tested for your application. Further details on request.

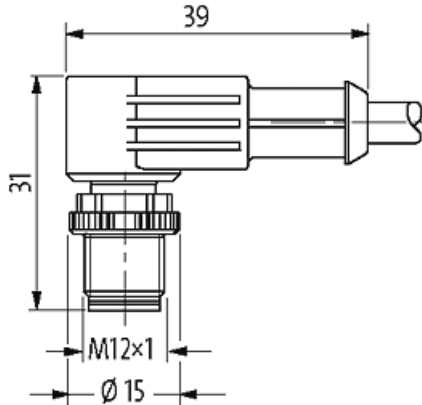
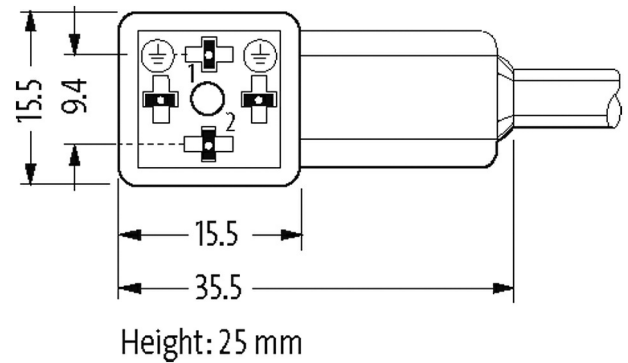
[Link to Product](#)**Illustration**

Female

Male



Product may differ from Image

**Form**

Form

41061

Technical Data	
Operating voltage	24 V AC $\pm 20\%$ / DC $\pm 25\%$
Operating current per contact	max. 4 A
Switch off peak	max. 55 V
Switch off delay time	max. 20 ms
LED display	(yellow)
Current consumption	approx. 12 mA
Housing	Black plastic (gray on request)
Locking of ports	M3/M12 \times 1 mm (recommended torque 0.4/0.6 Nm)
Protection	IP66K, IP67 inserted and tightened (EN 60529)
Rated surge voltage	0.8 kV
General data	
Temperature range	-25...+85 °C, depending on cable quality
Cables	
No./diameter of wires	3 \times 0.75 mm ²
Wire isolation	PVC (bk num, gnye)
Material (jacket)	PVC
Outer \varnothing	5.9 mm $\pm 5\%$
Bend radius (moving)	10 \times outer \varnothing
Temperature range (fixed)	-30...+70 °C
Temperature range (mobile)	-5...+70 °C
Cable identification	216
Cable Type	1 (PVC)
Approval (cable)	CE conform
Cable weight [g/m]	63,80
Material (wire)	Cu wire, bare
Resistor (core)	max. 26 Ω /km (20 °C)
Single wire \varnothing (core)	0.2 mm
Construction (core)	24 \times 0.2 mm (multi-strand wire class 5)
Diameter (core)	3 \times 0.75 mm ²
AWG	similar to AWG 18
Material (wire isolation)	PVC
Material property (wire isolation)	CFC-, cadmium-, silicone- and lead-free
Shore hardness (wire isolation)	43 ± 5 D
Wire- \varnothing incl. isolation	1.8 mm $\pm 5\%$
Color/numbering of wires	bk numbered, gnye longitudinally striped
Stranding combination	3 wires twisted
Shield	no
Material (jacket)	PVC
Material property (jacket)	CFC-, cadmium-, silicone- and lead-free
Shore hardness (jacket)	80 ± 5 A
Outer- \varnothing (jacket)	5.9 mm $\pm 5\%$
Color (jacket)	gray
chemical resistance	good resistance to oil, gasoline and chemicals
Nominal voltage	300/500 V AC
Test voltage	3000 V AC
Current load capacity	to DIN VDE 0298-4
Temperature range (fixed)	-30...+70 °C
Temperature range (mobile)	-5...+70 °C
Bend radius (fixed)	5 \times outer \varnothing
Bend radius (moving)	10 \times outer \varnothing
Jacket Color	gray
Commercial data	

country of origin	CZ
customs tariff number	85444290
EAN	4048879146494
eClass	27279218
Packaging unit	1