

MSUD valve plug A-18mm with cable

PVC 3x0.75 ye 10m

MSUD

Form A (18 mm)

110 V AC/DC $\pm 10\%$

LED and suppression

Further cable lengths on request.

Plastic housings with good resistance against chemicals and oils.

The resistance to aggressive media should be individually tested for your application. Further details on request.

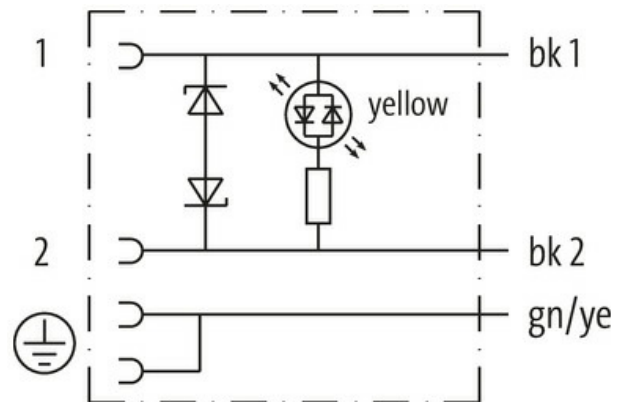
[Link to Product](#)**Illustration**

Height: 30 mm

Product may differ from Image



* only for products with UL/CSA approved cable

Form

Form 18041

Technical DataOperating voltage 110 V AC/DC $\pm 10\%$

Operating current per contact max. 4 A

Switch off peak max. 250 V

Locking of ports	M3 (recommended torque 0.4 Nm)
Protection	IP67 inserted and tightened (EN 60529)
Housing	Black plastic (gray on request)
Switch off delay time	max. 20 ms

General data

Temperature range	-25...+85 °C, depending on cable quality
-------------------	--

Cables

No./diameter of wires	3× 0.75 mm ²
Wire isolation	PVC (bk num, gnye)
Outer Ø	5.9 mm ±5%
Cable identification	016
Cable Type	1 (PVC)
Approval (cable)	CE conform
Cable weight [g/m]	63,8 g
Material (wire)	Cu wire, bare
Resistor (core)	max. 26 Ω/km (20 °C)
Single wire Ø (core)	0.2 mm
Construction (core)	24× 0.2 mm (multi-strand wire class 5)
Diameter (core)	3× 0.75 mm ²
AWG	similar to AWG 18
Material (wire isolation)	PVC
Material property (wire isolation)	CFC-, cadmium-, silicone- and lead-free
Shore hardness (wire isolation)	43 ±5 D
Wire-Ø incl. isolation	1.8 mm ±5%
Color/numbering of wires	bk numbered, gnye longitudinally striped
Stranding combination	3 wires twisted
Shield	no
Material (jacket)	PVC
Material property (jacket)	CFC-, cadmium-, silicone- and lead-free
Shore hardness (jacket)	80 ±5 A
Outer-Ø (jacket)	5.9 mm ±5%
Color (jacket)	yellow
Cable labeling	see frame delivery specifications 7000-00000-001
Jacket Color	yellow
chemical resistance	good resistance to oil, gasoline and chemicals
Nominal voltage	300/500 V AC
Test voltage	3000 V AC
Current load capacity	to DIN VDE 0298-4
Temperature range (fixed)	-30...+70 °C
Temperature range (fixed)	-30...+70 °C
Temperature range (mobile)	-5...+70 °C
Temperature range (mobile)	-5...+70 °C
Bend radius (fixed)	5× outer Ø
Bend radius (moving)	10× outer Ø
Bend radius (moving)	10× outer Ø
Material (jacket)	PVC

Commercial data

country of origin	CZ
customs tariff number	85444290
EAN	4048879193283
eClass	27279218
Packaging unit	1.000