

M12 female 90° A-cod. with cable LED NPN

PVC 4x0.34 bk UL/CSA 3m

Female 90°

M12, 4-pole

2× LED (NPN)

Art-No. 7005 - M12 Lite - (plastic hexagonal screw) on request

Plastic housings with good resistance against chemicals and oils.

The resistance to aggressive media should be individually tested for your application. Further details on request.

Further cable lengths on request.

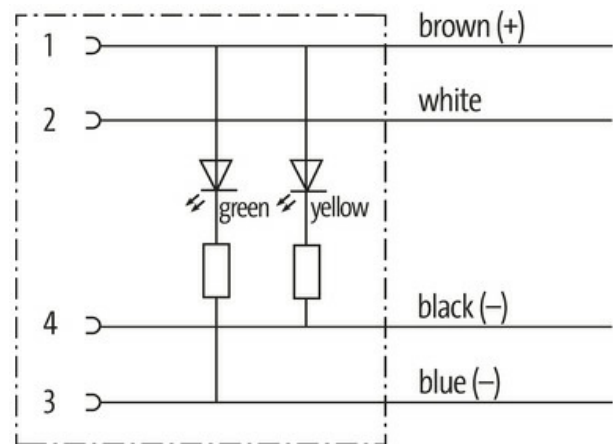
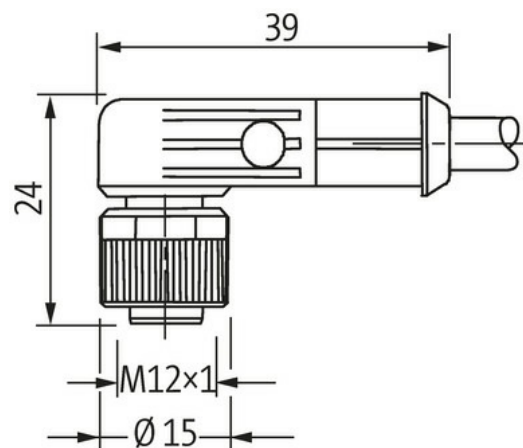
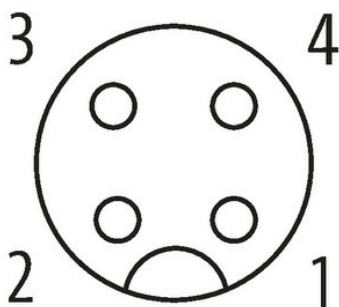
[Link to Product](#)**Illustration****Female**

Product may differ from Image



* only for products with UL/CSA approved cable

Form

Form

12415

Technical Data

Operating voltage	24 V DC $\pm 25\%$
Operating voltage (only UL listed)	max. 30 V DCmax. 30 V AC/DC
Rated surge voltage	0.8 kV
Operating current per contact	max. 4 A
LED display	yellow/green
Locking of ports	Screw thread (M12 \times 1 mm) recommended torque 0.6 Nm, self-securing
Compression gland	M12 (SW13)
Protection	IP65, IP66K, IP67 inserted and tightened (EN 60529)IP66K, IP67 inserted and tightened (EN 60529)
Locking material	Zinc die casting, matte nickel plated
suitable for corrugated tube (internal \varnothing)	10 mm

General data

Standards	DIN EN 61076-2-101 (M12)
Pollution Degree	3
Temperature range	-25...+85 °C, depending on cable quality

Cables

No./diameter of wires	4 \times 0.34 mm ²
Wire isolation	PVC (br, wh, bl, bk)
Outer \varnothing	5.0 mm $\pm 5\%$
Cable identification	614
Cable Type	1 (PVC)
Approval (cable)	UL (AWM-Style 2464/1731), CSA
Cable weight [g/m]	40,7 g
Material (wire)	Cu wire, bare
Resistor (core)	max. 60 Ω /km (20 °C)
Single wire \varnothing (core)	0.15 mm
Construction (core)	19 \times 0.15 mm (multi-strand wire class 5)
Diameter (core)	4 \times 0.34 mm ²
AWG	similar to AWG 22
Material (wire isolation)	PVC
Material property (wire isolation)	CFC-, cadmium-, silicone- and lead-free
Shore hardness (wire isolation)	45 ± 5 D
Wire- \varnothing incl. isolation	1.25 mm $\pm 5\%$
Color/numbering of wires	br, bk, bl, wh
Stranding combination	4 wires twisted
Shield	no
Material (jacket)	PVC
Material property (jacket)	CFC-, cadmium-, silicone- and lead-free
Shore hardness (jacket)	85 ± 5 A
Outer- \varnothing (jacket)	5.0 mm $\pm 5\%$
Color (jacket)	black
Jacket Color	black
chemical resistance	good resistance to oil, gasoline and chemicals
thermal resistance	flame retardant UL 1581 VW1 / CSA FT1
Nominal voltage	UL 300 V AC
Test voltage	2000 V AC
Current load capacity	to DIN VDE 0298-4
Temperature range (fixed)	-30...+80 °C
Temperature range (fixed)	-30...+80 °C
Temperature range (mobile)	-5...+80 °C
Temperature range (mobile)	-5...+80 °C
Bend radius (fixed)	5 \times outer \varnothing
Bend radius (moving)	10 \times outer \varnothing
Bend radius (moving)	10 \times outer \varnothing

The information in this brochure has been compiled with the utmost care.

Liability for the correctness completeness and topicality of the information is restricted to gross negligence. Version: 03/22

Material (jacket) PVC (UL/CSA)

Commercial data

country of origin	DE
customs tariff number	85444290
EAN	4048879352420
eClass	27279218
Packaging unit	1.000