

UFL 50 L PLUG FOR SIGNAL TRANSFER

24 VDC / 1 A - male with LED

Ribbon cable connector + LED

50-pole

Via the combined fixing mechanism, connectors with or without strain relief can be connected.

Link to Product

Illustration

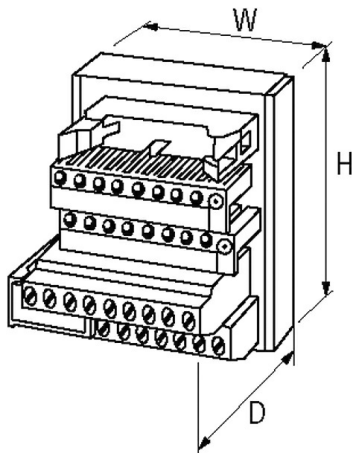
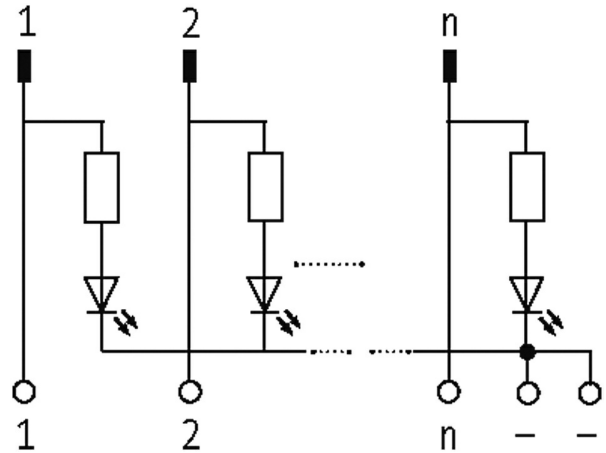

Product may differ from Image

Technical Data

Operating voltage	24 V AC
Material group	EN 60664-1 over voltage, category II
LED display	LED (red) Ø 3 mm per pole, acc. to potential -
Plug connector	for plugs with or without strain relief (DIN 41651); for plugs with strain relief, it may be necessary to remove the bottom hook
Operating current per bit	max. 1 A

General data

Mounting method	DIN-rail mountable (EN 60715)
Temperature range	-20...+70 °C
Dimensions H×W×D	63×140×48 mm

Commercial data

The information in this brochure has been compiled with the utmost care. Liability for the correctness completeness and topicality of the information is restricted to gross negligence. Version: 03/22

Murrelektronik Ltd. | 5 Albion Street, Pendlebury Industrial Estate, Swinton | Manchester M27 4FG | Fon +44 161 728 3133 | Fax +44 161 728 3130 | shop@murrelektronik.co.uk | shop.murrelektronik.co.uk

country of origin	CZ
customs tariff number	85366990
EAN	4048879026567
eClass	27141120
Packaging unit	1.000