

Mini (7/8) 4 pole, Female 90° w/ Cable

TPE 4x16AWG ye UL/CSA, TC-ER

Female 90°

7/8"

4-pole

Power cable

USA

without cable sleeves

Further cable lengths on request.

Plastic housings with good resistance against chemicals and oils.

The resistance to aggressive media should be individually tested for your application. Further details on request.

[Link to Product](#)

Illustration

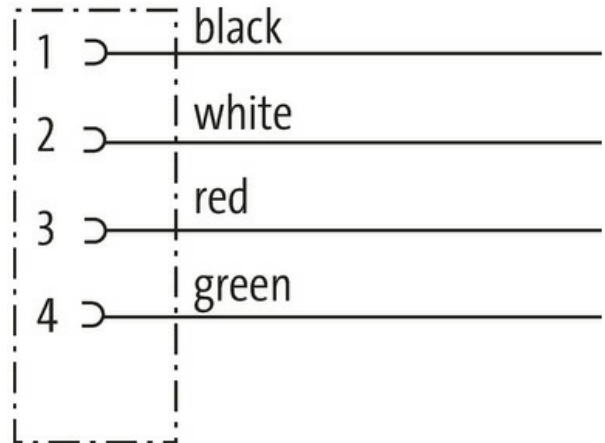
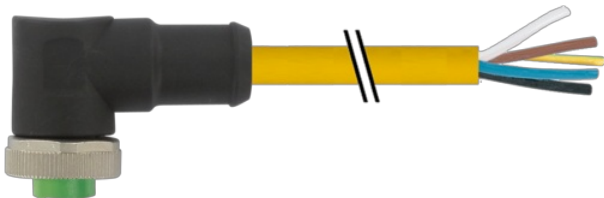

Female

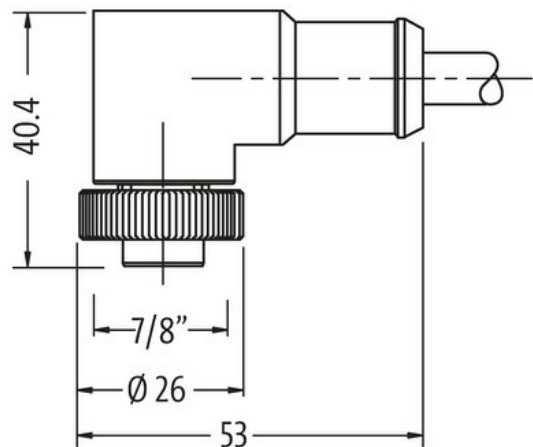
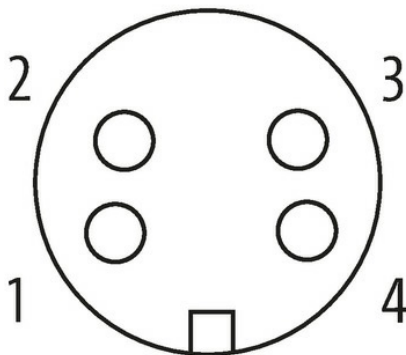

Product may differ from Image

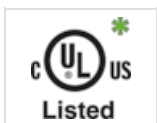

* only for products with UL/CSA approved cable

Form

Form

A4031

Technical Data

The information in this brochure has been compiled with the utmost care. Liability for the correctness completeness and topicality of the information is restricted to gross negligence. Version: 03/22

Operating voltage	max. 600 V AC/DC
Rated surge voltage	4.0 kV
Operating current per contact	max. 9 A
No. of poles	4
LED display	no
Locking of ports	Screw thread 7/8" (recommended torque 1.5 Nm) self-securing
Compression gland	7/8" (SW24)
Protection	IP68 inserted and tightened (EN 60529)
Material	PUR
Locking material	Zinc die casting, matte nickel plated

General data

Mounting method	inserted, tightened
Pollution Degree	3
Temperature range	-25...+80 °C, depending on cable quality

Cables

No./diameter of wires	4x 1.5 mm ²
Wire isolation	PVC (bk, gn, rd, wh)
Outer Ø	9.0 mm ±5%
Cable identification	U1C
Cable number	U1C
Approval (cable)	UL (AWM-Style 21002/1841), CSA
Cable weight [g/m]	117,7 g
Material (wire)	Cu wire, bare
Resistor (core)	max. 13.2 Ω/km (20 °C)
Single wire Ø (core)	0.16 mm
Construction (core)	65x 0.16 mm (multi-strand wire class 6)
Diameter (core)	4x 1.5 mm ²
AWG	similar to AWG 16
Material (wire isolation)	PVC
Wire-Ø incl. isolation	2.6 mm ±5%
Color/numbering of wires	bk, gn, rd, wh
Shield	no
Material (jacket)	TPE
Outer-Ø (jacket)	9.1 mm ±5%
Color (jacket)	yellow
Jacket Color	yellow
chemical resistance	good resistance to oil, gasoline and chemicals
thermal resistance	flame retardant UL, FT4
Nominal voltage	600 V
Test voltage	6 kV spark test
Current load capacity	NEC (National Electric Code)
Temperature range (fixed)	-50...+105 °C
Temperature range (fixed)	-50...+105 °C
Temperature range (mobile)	-20...+90 °C
Temperature range (mobile)	-20...+90 °C
Bend radius (fixed)	8x outer Ø
Bend radius (moving)	10x outer Ø
Bend radius (moving)	10x outer Ø
Torsion stress	±90°/m
Material (jacket)	TPE (UL/CSA)

Commercial data

country of origin	DE
-------------------	----

customs tariff number	85444290
EAN	4048879698290
eClass	27279218
Packaging unit	1.000