

VALVE PLUG SUPPRESSOR FORM BI - 11MM 90°

RC and LED, 110VAC/DC/10VA/W

110 V AC/DC

RC + LED

Remove plug gasket when fitting adapter. Other LED colors on request.

Note PIN arrangement (PE at cable outlet of connector). 180° turned version on request.

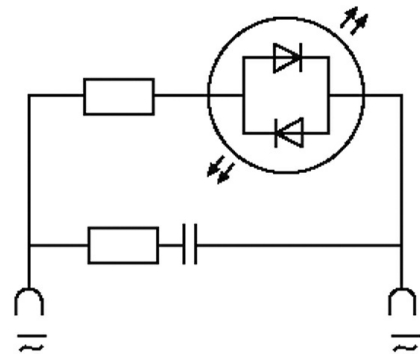
[Link to Product](#)**Illustration**

LED + RC

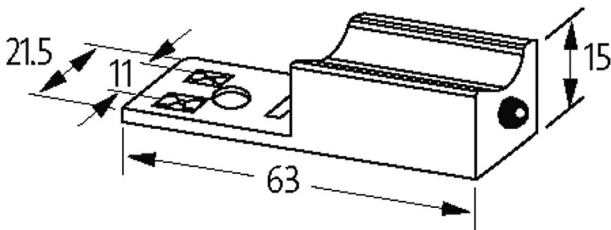

Product may differ from Image

Technical Data

Switch off peak	max. 250 V
LED display	(yellow opac)
Input voltage	95...132 V AC/DC
max. power (W)	max. 10 W (VA)
Switch off delay time	max. 20 ms

General data

Material (contact)	Silvered bronze
Temperature range	-20...+60 °C
Housing	Polyamide black, flame retardant, temperature resistance up to 130 °C
Dimensions H×W×D	15×63×21.5 mm

Commercial data

country of origin	CZ
customs tariff number	85363010
EAN	4048879012003
eClass	27371013
Packaging unit	1.000