

M12 female 0° A-cod. with cable

PVC 8x0.25 gy 15m

Female straight

M12, 8-pole

Art-No. 7005 - M12 Lite - (plastic hexagonal screw) on request
with cable sleeves

Plastic housings with good resistance against chemicals and oils.

The resistance to aggressive media should be individually tested for your application. Further details on request.

Further cable lengths on request.

[Link to Product](#)**Illustration**

1	white
2	brown
3	green
4	yellow
5	gray
6	pink
7	blue
8	red

Female

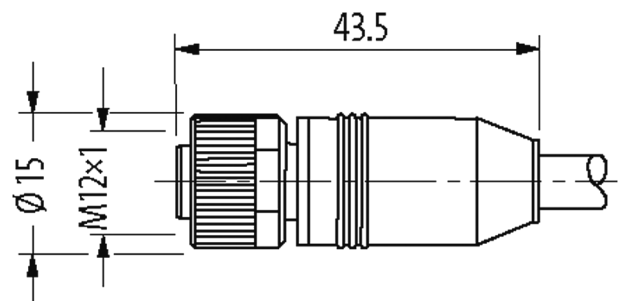

Product may differ from Image

* only for products with UL/CSA approved
cable**Form**

Form 17041

Technical Data

Operating voltage max. 30 V AC/DC

Operating voltage (only UL listed) max. 30 V AC/DC

Rated surge voltage	0.8 kV
Operating current per contact	max. 2 A
Material group	IEC 60664-1, category I
Coding	A-coded
Locking of ports	Screw thread (M12×1 mm) recommended torque 0.6 Nm, self-securing
Compression gland	M12 (SW13)
Protection	IP65, IP66K, IP67 inserted and tightened (EN 60529)
Locking material	Zinc die casting, matte nickel plated
Material	PUR

General data

Pollution Degree	3
Temperature range	-25...+85 °C, depending on cable quality

Cables

No./diameter of wires	8× 0.25 mm ²
Wire isolation	PVC (bl, wh, gn, ye, gr, pk, rd, br)
Material (jacket)	PVC
Outer Ø	6.0 mm ±5%
Bend radius (moving)	12× outer Ø
Temperature range (fixed)	-40...+70 °C
Temperature range (mobile)	-5...+70 °C
Cable identification	293
Approval (cable)	CE conform
Cable weight [g/m]	58,30
Material (wire)	Cu wire, bare
Resistor (core)	max. 78 Ω/km (20 °C)
Single wire Ø (core)	0.15 mm
Construction (core)	14× 0.15 mm (multi-strand wire class 5)
Diameter (core)	8× 0.25 mm ²
AWG	similar to AWG 24
Material (wire isolation)	PVC
Material property (wire isolation)	CFC-, cadmium-, silicone- and lead-free
Shore hardness (wire isolation)	90 ±3 A
Wire-Ø incl. isolation	1.2 mm ±5%
Color/numbering of wires	br, wh, rd, bl, pk, gr, ye, gn
Stranding combination	8 wires twisted around central filler
Shield	no
Material (jacket)	PVC
Material property (jacket)	CFC-, cadmium-, silicone- and lead-free, matt, low-adhesion, machine easy to process, abrasion-resistant
Shore hardness (jacket)	78 ±3 A
Outer-Ø (jacket)	6.0 mm ±5%
Color (jacket)	gray
chemical resistance	good resistance to oil, gasoline and chemicals
thermal resistance	flame retardant DIN VDE 0482 Teil 332-1-2 / IEC 60332-1-2
Nominal voltage	300/300 V AC
Test voltage	2000 V AC
Temperature range (fixed)	-40...+70 °C
Temperature range (mobile)	-5...+70 °C
Bend radius (moving)	12× outer Ø
Jacket Color	gray

Commercial data

country of origin	CZ
customs tariff number	85444290
EAN	4048879403450

eClass	27279218
Packaging unit	1