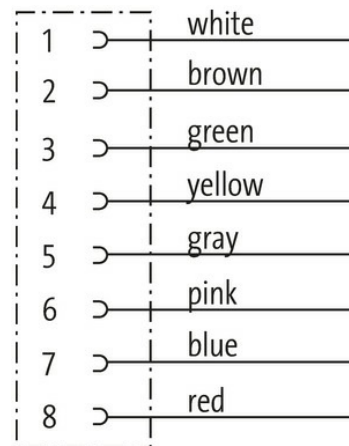
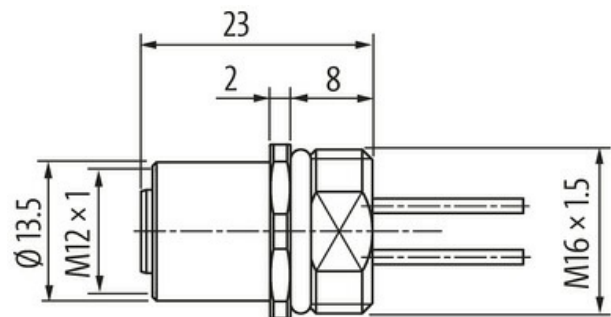
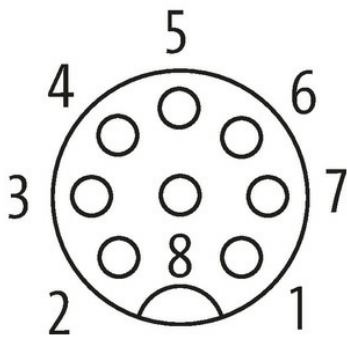

M12 female recept. A-cod. front incl. nut

PP-wires 8x0.25 0.2m

Flange female
M12, 8-pole
Front mounting
with multi-strand wire

[Link to Product](#)**Illustration****Female**

Product may differ from Image

**Form**

Form 17182

Technical Data

Operating voltage	max. 30 V AC/DC
Rated surge voltage	0.8 kV
Operating current per contact	max. 2 A

No. of poles	8
Material group	IEC 60664-1, category I
Coding	A-coded
LED display	no
Locking of ports	Screw thread (M12×1 mm) recommended torque 0.6 Nm, self-securing
Compression gland	M12 (SW14)
Protection	IP67 inserted and tightened (EN 60529)
Protection NEMA	3, 4, 6P (UL 50E)
Locking material	Zinc die casting, matte nickel plated

General data

Material (contact)	Copper alloy
Material (contact surface)	Au
Material (gasket)	FKM
Pollution Degree	3
Temperature range	-25...+85 °C, depending on cable quality

Cables

No./diameter of wires	8× 0.25 mm ²
Wire isolation	PUR (wh, br, gn, ye, gr, pk, bl, rd)
Outer Ø	1.25 mm ±5%
Cable number	973
Temperature range (fixed)	-40...+90 °C
Temperature range (mobile)	-25...+90 °C
Bend radius (fixed)	10× outer Ø

Commercial data

country of origin	DE
customs tariff number	85444290
EAN	4048879553803
eClass	27279220
Packaging unit	1.000