

**M12 male 90° X-cod. with cable shielded**

PUR 4x2xAWG26 shielded gn UL/CSA 25m

Ethernet CAT6A

Male 90°

M12, 8-pole  
shielded

Transmission properties with channel transmission up to 50 m

Further cable lengths on request.

Plastic housings with good resistance against chemicals and oils.

The resistance to aggressive media should be individually tested for your application. Further details on request.

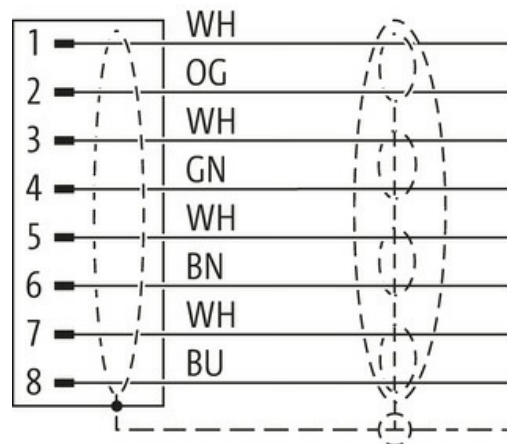
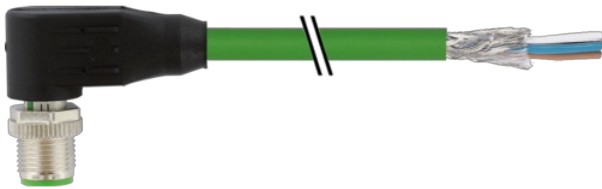
[Link to Product](#)**Illustration**

Male

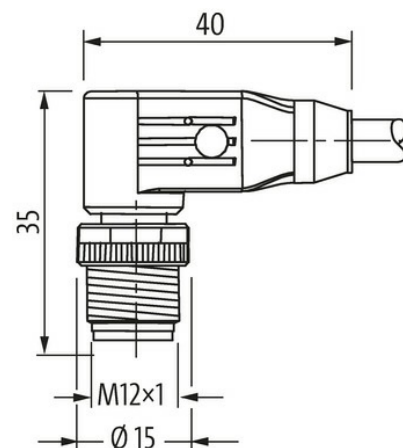
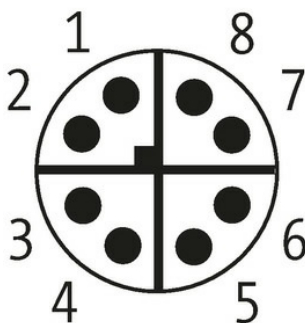

Product may differ from Image

**Form**

Form

21021

**Technical Data**

Operating voltage	max. 50 V AC/60 V DC
Rated surge voltage	1.5 kV
Operating current per contact	max. 0.5 A
No. of poles	8
Transfer parameters	CAT6, Class EA (ISO/IEC 11801:2002), (EN 50173-1)
Transfer rate	10 Gbit/s
Material group	IEC 60664-1, category I
Coding	X-coded
Locking of ports	Screw thread (M12×1 mm) recommended torque 0.6 Nm, self-securing
Compression gland	M12 (SW13)
Protection	IP65 and IP67 when plugged and screwed down (EN 60529)
Material	PUR
Locking material	Zinc die casting, matte nickel plated
suitable for corrugated tube (internal Ø)	without

#### General data

Standards	DIN EN 61076-2-109 (M12)
Mounting method	inserted, tightened
Pollution Degree	3
Temperature range	-25...+85 °C, depending on cable quality

#### Cables

Cable identification	790
Approval (cable)	cURus (AWM-Style 20549/11635); CE conform
Cable weight [g/m]	52,8 g
Material (wire)	Cu wire, bare
Resistor (core)	max. 143 Ω/km (20 °C)
Single wire Ø (core)	0.16 mm
Diameter (core)	4 × 2 × AWG26/7
Material (wire isolation)	PE
Wire-Ø incl. isolation	1.05 mm ±5%
Color/numbering of wires	(WH, OR), (WH, BU), (WH, BN), (WH, GN)
Shield	yes
optical shield cover	approx. 65%
Material (jacket)	PUR
Outer-Ø (jacket)	6.4 mm ±5%
Color (jacket)	green
chemical resistance	Oil resistance according to IEC 60811-2-1, ASTM IRM 901, ICEA S-82-552 Std.
Nominal voltage	125 V AC
Test voltage	1500 V (wire/wire); 1000 V (wire/shield)
Temperature range (fixed)	-40...+80 °C
Temperature range (mobile)	-30...+70 °C
Bend radius (fixed)	8 × outer Ø
Bend radius (moving)	10 × outer Ø

#### Commercial data

country of origin	DE
customs tariff number	85444290
EAN	4048879801225
eClass	27061801
Packaging unit	1.000