

Valve plug MJC 0° with cable V2A

PUR 2x0.75 bk 1.5m

Xtreme - Outdoor

Female straight

0...230 V AC/DC

without components

Stainless steel 1.4305 (V2A)

Plastic housings with good resistance against chemicals and oils.

The resistance to aggressive media should be individually tested for your application. Further details on request.

Further cable lengths on request.

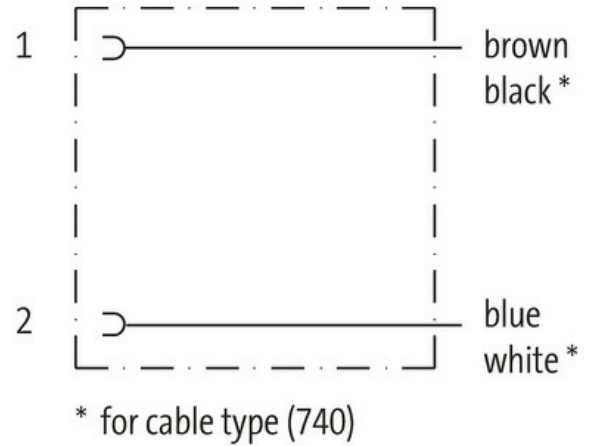
[Link to Product](#)**Illustration**

Product may differ from Image

Form

Form 70001

Technical Data

Operating voltage	max. 230 V AC/DC
Operating current per contact	max. 4 A
Protection	IP65 inserted and tightened (EN 60529)
Locking material	Stainless steel 1.4305 (V2A)

Housing Black plastic, flame retardant

General data

Temperature range -25...+85 °C, depending on cable quality

Cables

Cable identification	750
Approval (cable)	CE conform
Cable weight [g/m]	48,4 g
Material (wire)	Cu wire, bare
Resistor (core)	max. 26 Ω/km (20 °C)
Single wire Ø (core)	0.2 mm
Construction (core)	24× 0.2 mm (multi-strand wire class 5)
Diameter (core)	2× 0.75 mm ²
AWG	similar to AWG 18
Material (wire isolation)	PVC
Color/numbering of wires	br, bl
Stranding combination	2 wires twisted
Shield	no
Material (jacket)	PUR/PVC
Outer-Ø (jacket)	5.9 mm ±5%
Color (jacket)	black
chemical resistance	good resistance to oil, gasoline and chemicals
Nominal voltage	300 V AC
Test voltage	2000 V AC
Temperature range (fixed)	-40...+80 °C
Temperature range (mobile)	-5...+80 °C
Bend radius (moving)	15× outer Ø

Commercial data

country of origin	DE
customs tariff number	85444290
EAN	4048879316668
eClass	27279218
Packaging unit	1.000