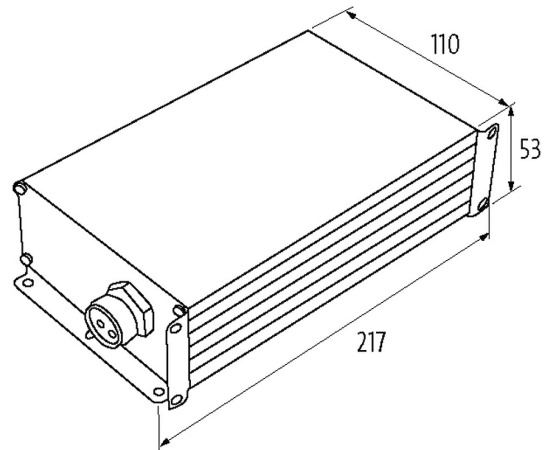

EMPARRO67 HYBRID POWER SUPPLY 1-PHASE, 2-CHANNELS

IN: 100-240VAC OUT: 24VDC/MAX. 10A (1-8/CHANNEL)

Emparro®67 Hybrid
 2× MICO 7/8" IOL
 5-pole
 Current: 10 A
 INPUT: 90...265 V AC/90...265 V DC
 OUTPUT: 24...28 V DC
 Preventive Diagnostic
 Over current protection device
 controllable via IO-Link

[Link to Product](#)**Illustration**

Product may differ from Image

**General data**

Standards	IEC 61010-2-201, EN 61204-3, EN 55022 B, EN 61000-3-2
Mounting method	6 hole screw mounting
Temperature range	-25...+50 °C, ...+80 °C derating (storage temperature -25...+85 °C)
MTBF	430 000 h
Relative humidity	4...100%
Protection	IP67
Efficiency	91.6% (115 V AC); 92.8% (230 V AC)
Dimensions H×W×D	216×110×53 mm

Output

Output voltage	24 V DC (SELV), ±1%; 24...28 V adjustable
LED display	LED (green): OK; LED (red): overload, overheating or short-circuit
Connection	7/8" (female), 5-pole
Output current	max. 8 A (per channel), max. 10 A (total)
Mains failure bridging time	min. 20 ms (230 V AC)
Ripple	max. 10 mV eff/rms
Spikes	max. 150 mV ss/pp
Unit protection	Short-circuit, overload and temperature

The information in this brochure has been compiled with the utmost care.
 Liability for the correctness completeness and topicality of the information is restricted to gross negligence. Version: 03/22

Parallel usage/serial usage	no
No. of channels	2x MICO (Over current protection device)

Input

Input voltage	90...265 V AC/90...265 V DC
Connection	7/8" (male), 3-pole
Input current	1.2 A (240 V AC)
Inrush current after 1 ms	max. 5.9 A (230 V AC)
Power factor	0.88 (230 V AC)
Frequency	50...60 Hz
Input fuse (internal)	6.3 A (T)

Commercial data

country of origin	CZ
customs tariff number	85044090
EAN	4048879634922
eClass	27049002
Packaging unit	1.000