

M12 male 90° A-cod. / MSUD valve plug A-18mm

PUR 5x0.34 gy UL/CSA 0.6m

MSUD

Form A (18 mm) – M12, male 90°

24 V DC $\pm 25\%$

LED (yellow/green)

for pressure switches

Further cable lengths on request.

Plastic housings with good resistance against chemicals and oils.

The resistance to aggressive media should be individually tested for your application. Further details on request.

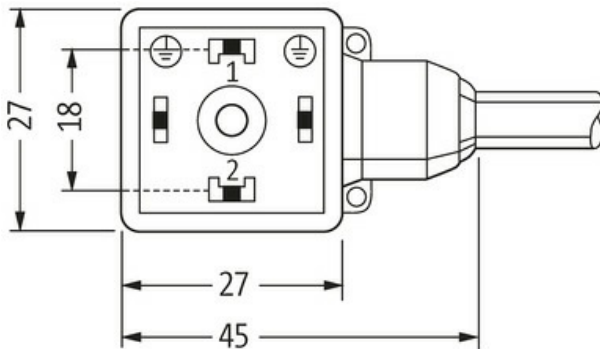
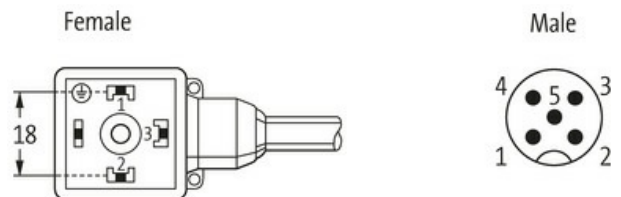
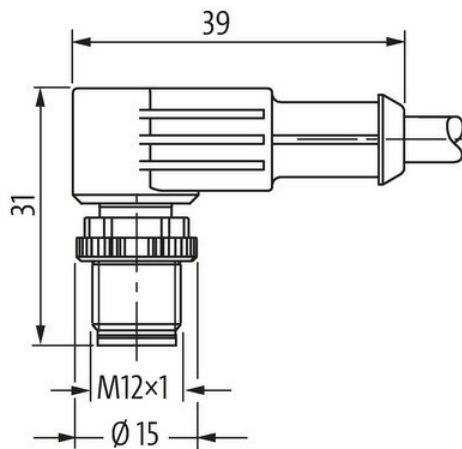
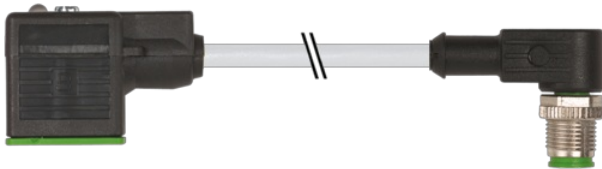
Link to Product**Illustration**

Height: 30 mm

Product may differ from Image

**Form**

Form 40951

Technical Data

Operating voltage	24 V DC $\pm 25\%$
Rated surge voltage	0.8 kV
Operating current per contact	max. 4 A
Current consumption	approx. 12 mA
Locking of ports	M3/M12 \times 1 mm (recommended torque 0.4/0.6 Nm)
Protection	IP66K, IP67 inserted and tightened (EN 60529)
Housing	Black plastic (gray on request)

General data

Temperature range -25...+85 °C, depending on cable quality

Cables

Cable identification	225
Cable Type	2 (PUR/PVC)
Approval (cable)	UL (AWM-Style 20549/1731), CSA; CE conform
Cable weight [g/m]	54,78 g
Material (wire)	Cu wire, bare
Resistor (core)	max. 57 Ω /km (20 °C)
Single wire \varnothing (core)	0.1 mm
Construction (core)	42 \times 0.1 mm (multi-strand wire class 6)
Diameter (core)	5 \times 0.34 mm ²
AWG	similar to AWG 22
Material (wire isolation)	PVC
Material property (wire isolation)	CFC-, cadmium-, silicone- and lead-free
Shore hardness (wire isolation)	43 \pm 5 D
Wire- \varnothing incl. isolation	1.25 mm $\pm 5\%$
Color/numbering of wires	br, bk, bl, wh, gnye longitudinally striped
Stranding combination	5 wires twisted around central filler
Shield	no
Material (jacket)	PUR/PVC
Material property (jacket)	CFC-, halogen-, cadmium-, silicone- and lead-free, matt, low-adhesion, machine easy to process, abrasion-resistant, hydrolysis and microbial resistant
Shore hardness (jacket)	80 \pm 5 A (PVC-under jacket); 85 \pm 5 A (PUR-jacket)
Outer- \varnothing (jacket)	5.0 mm $\pm 5\%$
Color (jacket)	gray
Cable labeling	see frame delivery specifications 7000-00000-001
chemical resistance	good resistance to oil, gasoline and chemicals
Nominal voltage	UL 300 V AC
Test voltage	2000 V AC
Current load capacity	to DIN VDE 0298-4
Temperature range (fixed)	-30...+80 °C
Temperature range (mobile)	-5...+80 °C
Bend radius (fixed)	10 \times outer \varnothing
Bend radius (moving)	15 \times outer \varnothing
No. of bending cycles (C-track)	max. 2 Mio. (25 °C)
Travel speed (C-track)	max. 3.3 m/s
Acceleration (C-track)	max. 5 m/s ²

Commercial data

country of origin	CZ
customs tariff number	85444290
EAN	4048879149518
eClass	27279218
Packaging unit	1.000