

**RJ45 Push Pull /RJ45 Push Pull male shielded AIDA**

PUR 1x4xAWG22 shielded gn UL/CSA 7.5m

Male straight – male straight

RJ45PP – RJ45PP, 4-pole

shielded

Push Pull

CAT5e

without cable sleeves

Further cable lengths on request.

Plastic housings with good resistance against chemicals and oils.

The resistance to aggressive media should be individually tested for your application. Further details on request.

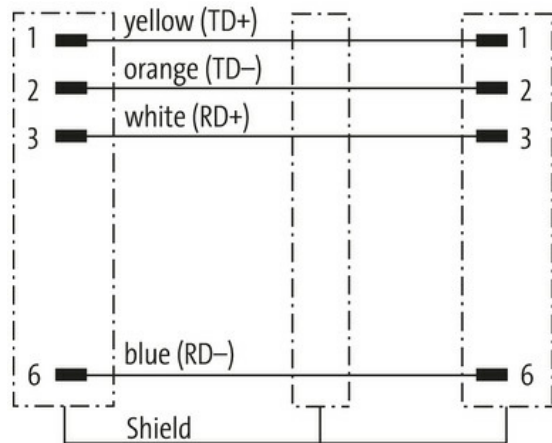
**[Link to Product](#)****Illustration**

Male



Male

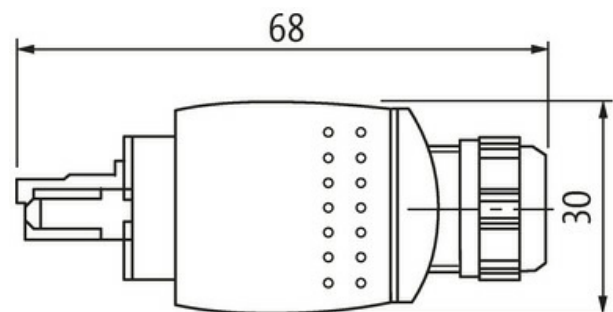
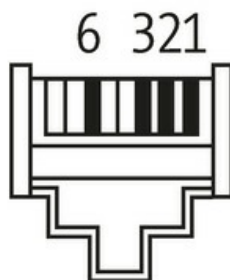

Height: 22 mm

Product may differ from Image

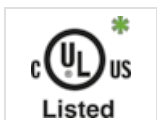

\* only for products with UL/CSA approved cable

**Form**

Form

99651

**Technical Data**

Operating voltage	max. 50 V DC
Operating voltage (only UL listed)	max. 30 V DC
Operating current per contact	max. 1.75 A
Transfer parameters	CAT5e, Class D (ISO/IEC 11801:2002), (EN 50173-1)
Locking of ports	Push Pull
Protection	IP65 and IP67 when plugged and screwed down (EN 60529)
Housing	Zinc die casting, nickel-plated

**General data**

Pollution Degree	3
Temperature range	-40...+70 °C, depending on cable quality

**Cables**

Cable identification	794
Approval (cable)	cURus (AWM-Style 20549/10578), CE-conform
Cable weight [g/m]	75,87 g
Material (wire)	Cu wire, bare
Resistor (core)	max. 55 Ω/km (20 °C)
Construction (core)	7× 0.254 mm
Diameter (core)	1× 4× AWG22/7
AWG	similar to AWG 22
Material (wire isolation)	PE
Wire-Ø incl. isolation	1.55 mm ±5%
Color/numbering of wires	wh, ye, bl, or
Shield	yes
optical shield cover	min. 85%
Material (jacket)	PUR
Outer-Ø (jacket)	6.7 mm ±5%
Color (jacket)	green
chemical resistance	Oil resistance according to IEC 60811-2-1, ASTM IRM 901, ICEA S-82-552 Std.
thermal resistance	flame-retardant according to UL 1581 section 1090, section 1100 (FT2), IEC 60332-1-2 Std.
Nominal voltage	300 V
Temperature range (fixed)	-40...+80 °C
Temperature range (mobile)	-30...+70 °C
Bend radius (fixed)	6× outer Ø
Bend radius (moving)	12× outer Ø

**Commercial data**

country of origin	DE
customs tariff number	85444210
EAN	4048879331333
eClass	27061801
Packaging unit	1.000