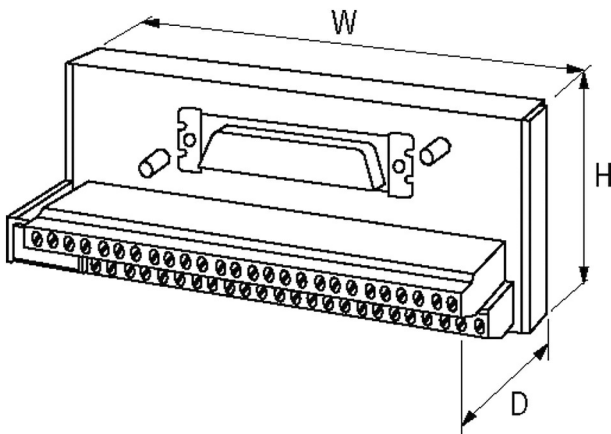
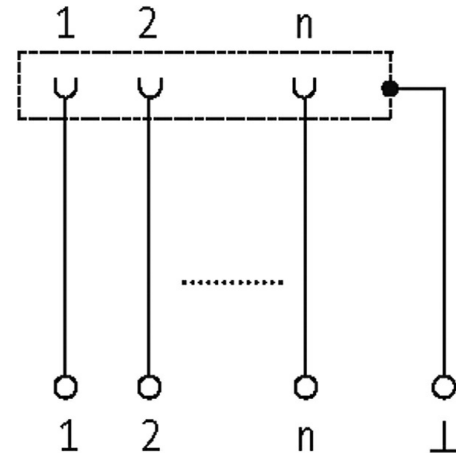

SV-SUB D 15ST.-KL FK

Male connector
15-pole
Spring clamp terminals

[Link to Product](#)**Illustration**

Product may differ from Image

Technical Data

Operating voltage	125 V AC/150 V DC
Material group	EN 60664-1 over voltage, category II
Locking of ports	Standard UNC 4-40 screw thread bolt (EN 60807)
Operating current per bit	max. 2 A

General data

Mounting method	DIN-rail mountable (EN 60715)
Temperature range	-20...+70 °C
Dimensions H×W×D	63×75×48 mm

Commercial data

country of origin	CZ
customs tariff number	85366990
EAN	4048879021616
eClass	27379201

Packaging unit

1.000