

**M12 female 0° A-cod. with cable shielded**

PUR 5x0.34 shielded gy UL/CSA 20m

Female straight  
M12, 5-pole  
shielded  
with cable sleeves

Plastic housings with good resistance against chemicals and oils.

The resistance to aggressive media should be individually tested for your application. Further details on request.  
Further cable lengths on request.

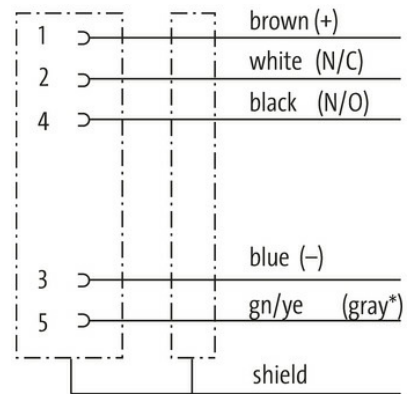
**[Link to Product](#)****Illustration**

(\* for cable type 203, 603, 243, 643)

**Female**

Product may differ from Image



\* only for products with UL/CSA approved cable

**Form**

The information in this brochure has been compiled with the utmost care.  
Liability for the correctness completeness and topicality of the information is restricted to gross negligence. Version: 03/22

Form	13221
<b>Technical Data</b>	
Operating voltage	max. 60 V AC/DC
Operating voltage (only UL listed)	max. 30 V AC/DC
Rated surge voltage	1.5 kV
Operating current per contact	max. 4 A
Material group	IEC 60664-1, category I
Coding	A-coded
Locking of ports	Screw thread (M12×1 mm) recommended torque 0.6 Nm, self-securing
Compression gland	M12 (SW13)
Protection	IP65, IP66K, IP67 inserted and tightened (EN 60529)
Material	PUR
Locking material	Zinc die casting, matte nickel plated
suitable for corrugated tube (internal Ø)	without
<b>General data</b>	
Standards	DIN EN 61076-2-101 (M12)
Pollution Degree	3
Stripping length (jacket)	20 mm
Temperature range	-25...+85 °C, depending on cable quality
<b>Cables</b>	
No./diameter of wires	5× 0.34 mm <sup>2</sup>
Wire isolation	PP (br, wh, bl, bk, gnye)
Outer Ø	6.9 mm ±5%
Cable number	351
Approval (cable)	UL (AWM-Style 20233/1992), CSA; CE conform
Diameter (core)	5× 0.34 mm <sup>2</sup>
Shield	yes
Color (jacket)	gray
Jacket Color	gray
Temperature range (fixed)	-40...+80 °C
Temperature range (mobile)	-20...+80 °C
Bend radius (fixed)	10× outer Ø
Bend radius (moving)	15× outer Ø
Material (jacket)	PUR (UL/CSA)
<b>Commercial data</b>	
country of origin	CZ
customs tariff number	85444290
EAN	4048879199704
eClass	27279218
Packaging unit	1.000