

**M12 male 90° / M12 female 90° A-cod.**

PUR 12x0.14 bk UL/CSA+drag ch. 1m

Male 90° – female 90°

M12 – M12, 12-pole

Art-No. 7005 - M12 Lite - (plastic hexagonal screw) on request

Plastic housings with good resistance against chemicals and oils.

The resistance to aggressive media should be individually tested for your application. Further details on request.

Further cable lengths on request.

**Link to Product**

**Illustration**

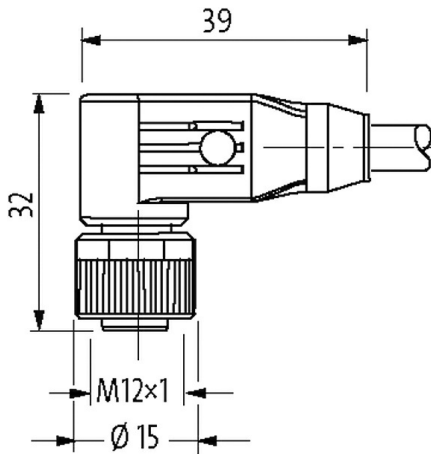
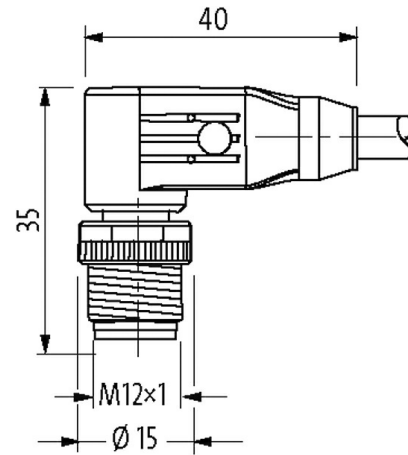

1	■	brown	c 1
2	■	blue	c 2
3	■	white	c 3
4	■	green	c 4
5	■	pink	c 5
6	■	yellow	c 6
7	■	black	c 7
8	■	gray	c 8
9	■	red	c 9
10	■	violet	c 10
11	■	gray/pink	c 11
12	■	red/blue	c 12

Male

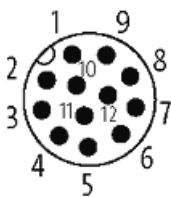

Female

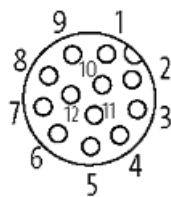

Product may differ from Image

**Form**

Form 53061

**Technical Data**

Operating voltage	max. 30 V AC/DC
Operating current per contact	max. 1.5 A
Locking of ports	Screw thread (M12×1 mm) recommended torque 0.6 Nm, self-securing
Locking material	Zinc die casting, matte nickel plated
Protection	IP66K, IP67 inserted and tightened (EN 60529)
Rated surge voltage	0.8 kV

**Cables**

No./diameter of wires	12× 0.14 mm <sup>2</sup>
Wire isolation	PP (br, bl, wh, gn, pk, ye, bk, gr, rd, vi, grpk, rdbl)
C-track properties	2 Mio.
Material (jacket)	PUR (UL/CSA)
Outer Ø	6.0 mm ±5%
Bend radius (moving)	10× outer Ø
Temperature range (fixed)	-40...+85 °C
Temperature range (mobile)	-25...+85 °C
Cable identification	705
Approval (cable)	UL (AWM-Style 20233/10493), CSA; CE conform
Cable weight [g/m]	45,10
Material (wire)	Cu wire, bare
Resistor (core)	max. 138 Ω/km (20 °C)
Single wire Ø (core)	0.1 mm
Construction (core)	18× 0.1 mm (multi-strand wire class 6)
Diameter (core)	12× 0.14 mm <sup>2</sup>
AWG	similar to AWG 26
Material (wire isolation)	PP
Material property (wire isolation)	CFC-, halogen-, cadmium-, silicone- and lead-free
Wire-Ø incl. isolation	1.0 mm ±5%
Color/numbering of wires	br, rd, gr, bk, ye, pk, gn, wh, bl, rdbl, grpk, vi
Shield	no
Material (jacket)	PUR
Shore hardness (jacket)	92 ±5 A
Outer-Ø (jacket)	6.0 mm ±5%
Color (jacket)	black
chemical resistance	good resistance to oil, gasoline and chemicals (VDE 0472 Teil 803 Test B)
Nominal voltage	300 V AC
Test voltage	1500 V AC
Temperature range (fixed)	-40...+85 °C
Temperature range (mobile)	-25...+85 °C
Bend radius (fixed)	7.5× outer Ø
Bend radius (moving)	10× outer Ø
No. of bending cycles (C-track)	max. 2 Mio. (25 °C)
Traversing distance (C-track)	max. 5 m (horizontal)
Travel speed (C-track)	max. 3.3 m/s
Acceleration (C-track)	max. 5 m/s <sup>2</sup>
Torsion stress	±180°/m

