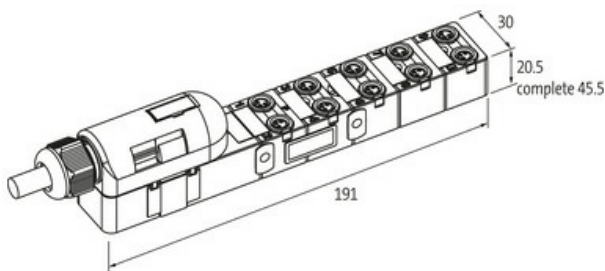
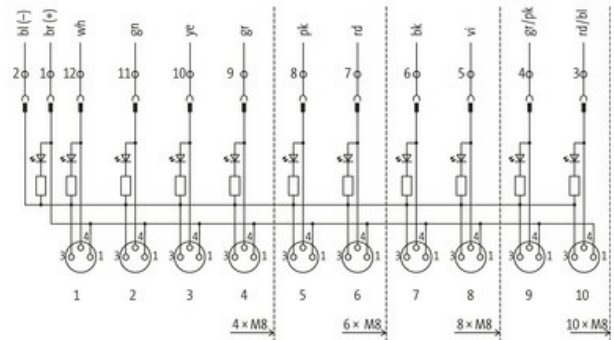

EXACT8, 10XM8, 3 POLE PLUG. CAP, SPRING-TERM.

5.0m PUR 10*0,34+2*0,75 exit norm..

5.0 m

[Link to Product](#)**Illustration**

M8-Females 3-pole

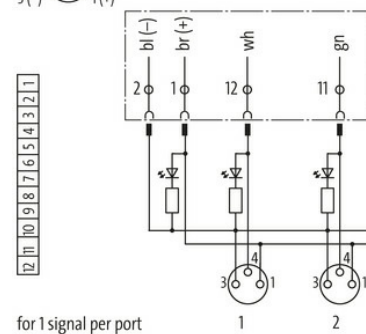

for 1 signal per port

Product may differ from Image

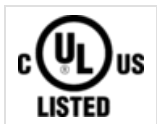
**Form**

Form 80040

Technical Data

Operating voltage	24 V DC
Operating current per contact	max. 2 A
Locking of ports	Screw thread (M8x1 mm)
Connection	Spring clamp plug-in terminals: max. 1.5 mm ² (AWG 16)
Protection	IP67 inserted and tightened (EN 60529)
Housing	Plastic, flame retardant
Signal per port	1 - (31-32)
Total current	max. 8 A

General data

Temperature range -20...+80 °C, depending on cable quality

Cables

No./diameter of wires 10× 0.34 + 2× 0.75 mm²

C-track properties 5 Mio.

Outer Ø 9.3 mm ±5%

Cable number 384

Approval (cable) UL (AWM-Style 20233), CSA

Color (jacket) gray

Jacket Color gray

Temperature range (fixed) -40...+80 °C

Temperature range (mobile) -5...+60 °C

Bend radius (fixed) 5× outer Ø

Bend radius (moving) 10× outer Ø

Material (jacket) PUR (UL/CSA)

Contact Layout

PIN 1 (+)

PIN 3 (-)

PIN 4 (NO)/(S1)

LED (green): Power / LED (yellow): (S1)

Commercial data

country of origin CZ

customs tariff number 85444290

EAN 4048879056885

eClass 27279219

Packaging unit 1.000