

M8 male 90° with cable, 180°

PUR 5x0.25 bk UL 7,5m

Male 90°
M8, 5-pole
B-coded
with cable sleeves

Attention: Contact carrier turned to 180°!

Plastic housings with good resistance against chemicals and oils.

The resistance to aggressive media should be individually tested for your application. Further details on request.
Further cable lengths on request.

Link to Product

Illustration

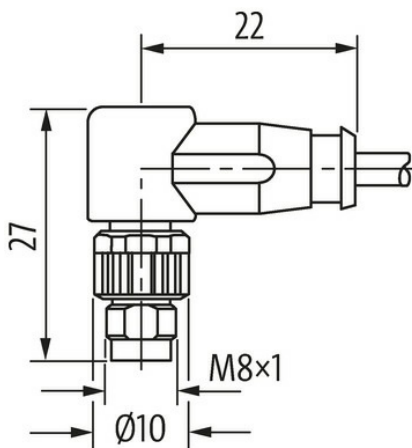
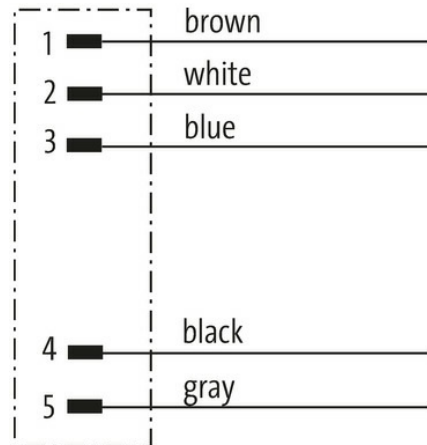
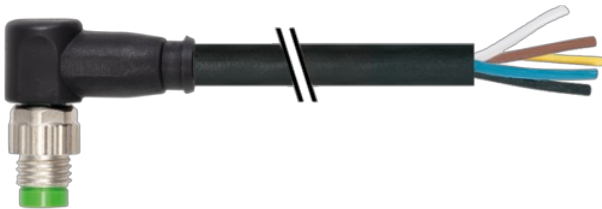

Male

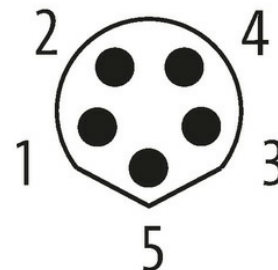

Product may differ from Image



Form

Form 08912

Technical Data

The information in this brochure has been compiled with the utmost care.
Liability for the correctness completeness and topicality of the information is restricted to gross negligence. Version: 03/22

Operating voltage	max. 30 V AC/DC
No. of poles	5
Mating cycles	≥ 100

General data

Mounting method	inserted, tightened
Material (contact)	Copper alloy
Material (contact surface)	Au
Pollution Degree	3/2
Temperature range	-25...+80 °C

Cables

Cable identification	695
Material (wire)	Cu wire, bare
Resistor (core)	max. 58 Ω/km (20 °C)
Single wire Ø (core)	0.1 mm
Construction (core)	32× 0.1 mm (multi-strand wire class 6)
Diameter (core)	5× 0.25 mm ²
AWG	similar to AWG 24
Material (wire isolation)	PP
Wire-Ø incl. isolation	1.2 mm ±5%
Stranding combination	5 wires twisted around central filler
Shield	no
Material (jacket)	PUR
Outer-Ø (jacket)	4.7 mm ±5%
Color (jacket)	black
Nominal voltage	300 V
Test voltage	3000 V AC
Temperature range (fixed)	-25...+80 °C
Temperature range (mobile)	-10...+80 °C
Bend radius (moving)	7.5× outer Ø
No. of bending cycles (C-track)	max. 5 Mio. (25 °C)
Travel speed (C-track)	max. 3 m/s
Acceleration (C-track)	max. 5 m/s ²

Commercial data

country of origin	CZ
customs tariff number	85444290
EAN	4048879783347
eClass	27279218
Packaging unit	1.000