

Drive Cliq IP20/ M12 fem. recept. A-cod. shielded

PUR 0.20+0.38 shielded gn UL/CSA+drag ch. 5m

Ethernet CAT5

Flange female straight – male straight

DRIVE-CLiQ IP20

M12, 8-pole

partly used

shielded

without cable sleeves

Rear mounting

Further cable lengths on request.

The resistance to aggressive media should be individually tested for your application. Further details on request.

Link to Product**Illustration**

Female



Male

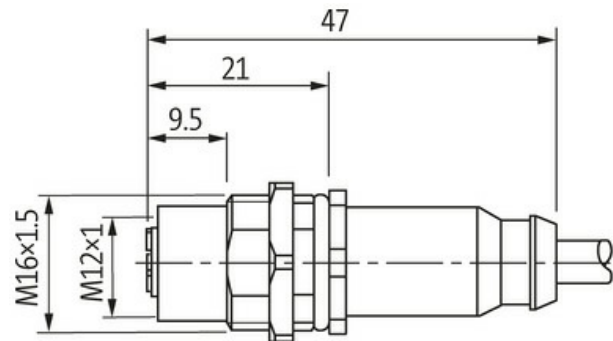

Product may differ from Image



Form

Form SS075

Technical Data

Operating voltage	max. 30 V AC/DC
Rated surge voltage	0.5 kV
Operating current per contact	max. 1.76 A
Transfer parameters	CAT5, Class D (ISO/IEC 11801:2002), (EN 50173-1)
Transfer rate	up to 100 Mbit/s full duplex

Material group	IEC 60664-1, category II
Coding	A-coded
Locking of ports	Screw thread (M12×1 mm) recommended torque 0.6 Nm, self-securing
Compression gland	M12 (SW14)
Protection	IP67 (M12) - IP20 (DRIVE-CLiQ)
Protection NEMA	3, 4, 6P (UL 50E) (M12)
Material	PUR
Locking material	Brass, nickel plated

General data

Pollution Degree	3
Temperature range	-25...+85 °C, depending on cable quality

Cables

No./diameter of wires	2× 2× 0.20 + 1× 2× 0.38
Wire isolation	PO (gnye, pkbl, rdbk)
C-track properties	5 Mio.
Outer Ø	6.9 mm ±5%
Cable number	880
Shield	yes
optical shield cover	min. 85%
Material (jacket)	PUR
Jacket Color	green
Temperature range (fixed)	-20...+80 °C
Temperature range (mobile)	-20...+60 °C
Bend radius (moving)	10× outer Ø
Torsion stress	±30°/m
Material (jacket)	PUR (UL/CSA)

Commercial data

country of origin	DE
customs tariff number	85444210
EAN	4048879618298
eClass	27061801
Packaging unit	1.000