

**Valve plug MJC 0° with cable V2A**

PUR 2x0.5 bk drag ch. 3m

Xtreme - Outdoor

Female straight

0...230 V AC/DC

without components

Stainless steel 1.4305 (V2A)

Plastic housings with good resistance against chemicals and oils.

The resistance to aggressive media should be individually tested for your application. Further details on request.

Further cable lengths on request.

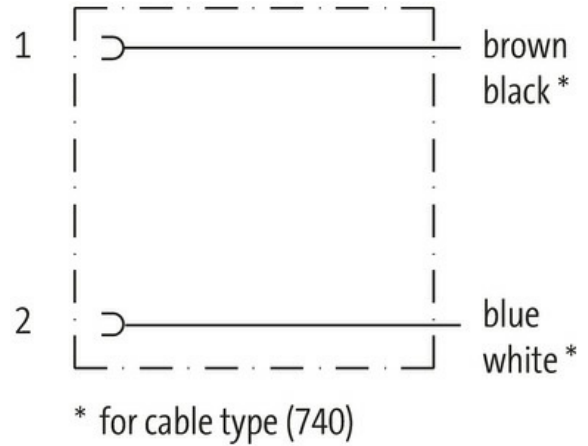
**Link to Product****Illustration**

Product may differ from Image

**Form**

Form 70001

**Technical Data**

Operating voltage	max. 230 V AC/DC
Operating current per contact	max. 4 A
Protection	IP65 inserted and tightened (EN 60529)
Locking material	Stainless steel 1.4305 (V2A)

Housing Black plastic, flame retardant

#### General data

Temperature range -25...+85 °C, depending on cable quality

#### Cables

No./diameter of wires	2× 0.5 mm <sup>2</sup>
Wire isolation	TPE (bk, wh)
C-track properties	2 Mio.
Outer Ø	5.0 mm ±5%
Cable identification	740
Approval (cable)	CE conform
Cable weight [g/m]	36,3 g
Material (wire)	Cu wire, bare
Resistor (core)	max. 39 Ω/km (20 °C)
Single wire Ø (core)	0.1 mm
Construction (core)	64× 0.1 mm (multi-strand wire class 6)
Diameter (core)	2× 0.5 mm <sup>2</sup>
AWG	similar to AWG 20
Material (wire isolation)	TPE-E
Wire-Ø incl. isolation	1.5 mm ±5%
Color/numbering of wires	bk, wh
Stranding combination	2 wires twisted
Shield	no
Material (jacket)	PUR
Outer-Ø (jacket)	5.0 mm ±5%
Color (jacket)	black
Jacket Color	black
Nominal voltage	300/500 V AC
Test voltage	2000 V AC
Temperature range (fixed)	-50...+90 °C
Temperature range (fixed)	-50...+90 °C
Temperature range (mobile)	-30...+90 °C
Temperature range (mobile)	-30...+90 °C
Bend radius (moving)	10× outer Ø
Bend radius (moving)	10× outer Ø
No. of bending cycles (C-track)	max. 2 Mio. (25 °C)
Travel speed (C-track)	max. 3.3 m/s
Acceleration (C-track)	max. 5 m/s <sup>2</sup>
Material (jacket)	PUR

#### Commercial data

country of origin	DE
customs tariff number	85444290
EAN	4048879316620
eClass	27279218
Packaging unit	1.000