

Push Pull Power with cable AIDA

PUR 5x2.5 gy UL/CSA+drag ch. 0.6m

Male straight

PPP, 5-pole

Push Pull Power

with cable sleeves

Further cable lengths on request.

Plastic housings with good resistance against chemicals and oils.

The resistance to aggressive media should be individually tested for your application. Further details on request.

Link to Product

Illustration

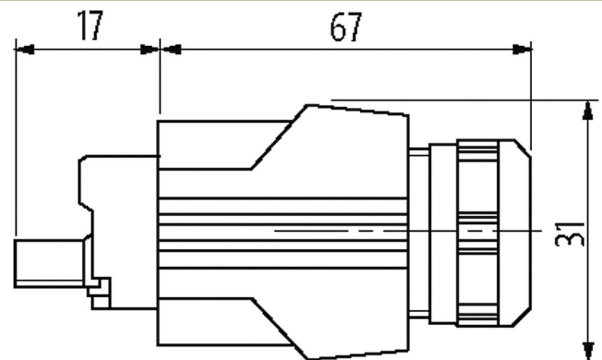
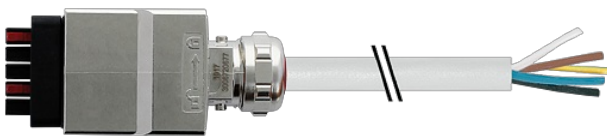

Height: 36 mm

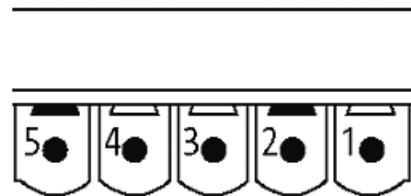
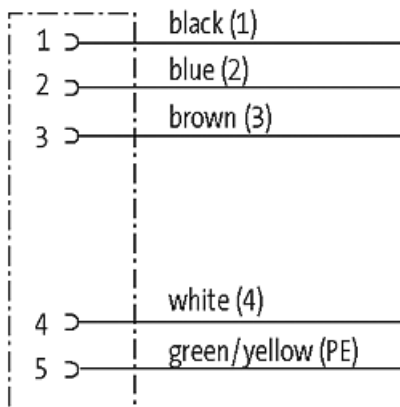

Product may differ from Image

Form

Form 99621

Technical Data

Operating voltage	max. 24 V AC/DC
Operating current per contact	max. 16 A
Locking of ports	Push Pull
Protection	IP65 and IP67 when plugged and screwed down (EN 60529)

General data

Pollution Degree 2

Temperature range -40...+85 °C, depending on cable quality

Cables	
No./diameter of wires	5× 2.5 mm ²
Wire isolation	PP (br, wh, bl, bk num, gnye)
C-track properties	5 Mio.
Material (jacket)	PUR (UL/CSA)
Outer Ø	9.7 mm ±5%
Bend radius (moving)	10× outer Ø
Temperature range (fixed)	-50...+80 °C
Temperature range (mobile)	-20...+80 °C
Cable identification	962
Approval (cable)	UL (AWM-Style 21223/11172), CSA; CE
Cable weight [g/m]	190,30
Material (wire)	Cu wire, bare
Resistor (core)	max. 7.98 Ω/km (20 °C)
Single wire Ø (core)	0.15 mm
Construction (core)	140× 0.15 mm (multi-strand wire class 6)
Diameter (core)	5× 2.5 mm ²
AWG	similar to AWG 14
Material (wire isolation)	PP
Material property (wire isolation)	CFC-, cadmium-, silicone- and lead-free
Shore hardness (wire isolation)	60 ±5 D
Wire-Ø incl. isolation	2.8 mm ±5%
Color/numbering of wires	bl, bk, wh, br, num; gnye longitudinally striped
Stranding combination	5 wires twisted around central filler
Shield	no
Material (jacket)	PUR
Material property (jacket)	CFC-, halogen-, cadmium-, silicone- and lead-free, matt, low-adhesion, machine easy to process, abrasion-resistant, hydrolysis and microbial resistant
Shore hardness (jacket)	90 ±5 A
Outer-Ø (jacket)	9.7 mm ±5%
Color (jacket)	gray
chemical resistance	good resistance to oil, gasoline and chemicals (VDE 0472 Teil 803 Test B)
Nominal voltage	600 V AC
Test voltage	3000 V AC
Current load capacity	to DIN VDE 0298-4
Temperature range (fixed)	-50...+80 °C
Temperature range (mobile)	-20...+80 °C
Bend radius (fixed)	7.5× outer Ø
Bend radius (moving)	10× outer Ø
No. of bending cycles (C-track)	max. 5 Mio. (25 °C)
Traversing distance (C-track)	max. 5 m (horizontal)
Travel speed (C-track)	max. 3.3 m/s
Acceleration (C-track)	max. 5 m/s ²
Jacket Color	gray
Commercial data	
country of origin	CZ
customs tariff number	85444290
EAN	4048879486774
eClass	27061801
Packaging unit	1