

M12 male 90° / M12 female 90° A-cod. LED

PVC 5x0.34 ye UL/CSA 0.6m

Male 90° – female 90°

M12 – M12, 5-pole

3× LED (PNP), (NPN) on request

Art-No. 7005 - M12 Lite - (plastic hexagonal screw) on request

Plastic housings with good resistance against chemicals and oils.

The resistance to aggressive media should be individually tested for your application. Further details on request.

Further cable lengths on request.

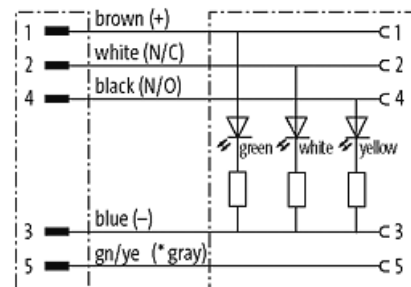
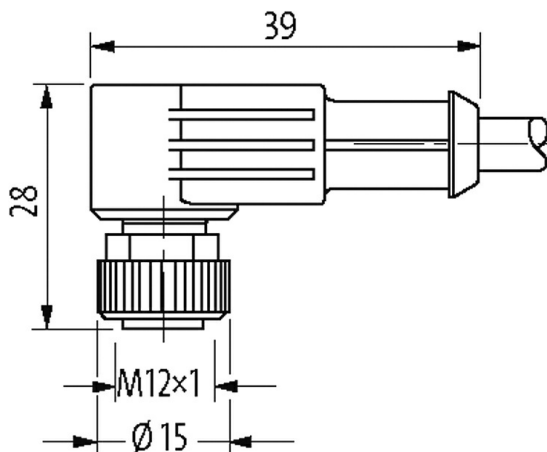
Link to Product**Illustration**

(* for cable type 126, 732, 219, 619)

Male



Female



Product may differ from Image



* only for products with UL/CSA approved cable

Form	
Form	40441
Technical Data	
Operating voltage	24 V DC $\pm 25\%$
Operating voltage (only UL listed)	max. 30 V DC
Operating current per contact	max. 4 A
Material group	IEC 60664-1, category I
Coding	A-coded
LED display	LED (green): Power / LED (yellow): (S1) / LED (white): Signal (S2)
Locking of ports	Screw thread (M12 \times 1 mm) recommended torque 0.6 Nm, self-securing
Compression gland	M12 (SW13)
Protection	IP66K, IP67 inserted and tightened (EN 60529)
Locking material	Zinc die casting, matte nickel plated
Material	PUR
suitable for corrugated tube (internal \varnothing)	10 mm
General data	
Pollution Degree	3
Temperature range	-25...+85 °C, depending on cable quality
Cables	
No./diameter of wires	5 \times 0.34 mm ²
Wire isolation	PVC (br, wh, bl, bk, gnye)
Material (jacket)	PVC (UL/CSA)
Outer \varnothing	5.2 mm $\pm 5\%$
Bend radius (moving)	10 \times outer \varnothing
Temperature range (fixed)	-30...+80 °C
Temperature range (mobile)	-5...+80 °C
Cable identification	015
Cable Type	1 (PVC)
Approval (cable)	UL (AWM-Style 2464/1731), CSA
Cable weight [g/m]	48,40
Material (wire)	Cu wire, bare
Resistor (core)	max. 60 Ω /km (20 °C)
Single wire \varnothing (core)	0.15 mm
Construction (core)	19 \times 0.15 mm (multi-strand wire class 5)
Diameter (core)	5 \times 0.34 mm ²
AWG	similar to AWG 22
Material (wire isolation)	PVC
Material property (wire isolation)	CFC-, cadmium-, silicone- and lead-free
Shore hardness (wire isolation)	45 ± 5 D
Wire- \varnothing incl. isolation	1.25 mm $\pm 5\%$
Color/numbering of wires	br, bk, bl, wh, gnye longitudinally striped
Stranding combination	5 wires twisted around central filler
Shield	no
Material (jacket)	PVC
Material property (jacket)	CFC-, cadmium-, silicone- and lead-free
Shore hardness (jacket)	85 ± 5 A
Outer- \varnothing (jacket)	5.2 mm $\pm 5\%$
Color (jacket)	yellow

The information in this brochure has been compiled with the utmost care.

Liability for the correctness completeness and topicality of the information is restricted to gross negligence. Version: 03/22

chemical resistance	good resistance to oil, gasoline and chemicals
thermal resistance	flame retardant UL 1581 VW1 / CSA FT1
Nominal voltage	UL 300 V AC
Test voltage	2000 V AC
Current load capacity	to DIN VDE 0298-4
Temperature range (fixed)	-30...+80 °C
Temperature range (mobile)	-5...+80 °C
Bend radius (fixed)	5× outer Ø
Bend radius (moving)	10× outer Ø
Jacket Color	yellow

Commercial data

country of origin	DE
customs tariff number	85444290
eClass	27061801
Packaging unit	1