

MOTOR SUPPRESSOR

Varistor, 3x400VAC/4kW

3 × 400 V AC

VDR

isolated M6

Suppressors for other voltages, frequencies, and motor ratings available on request. Do not use RC motor suppressors with frequency inverters.

[Link to Product](#)

Illustration

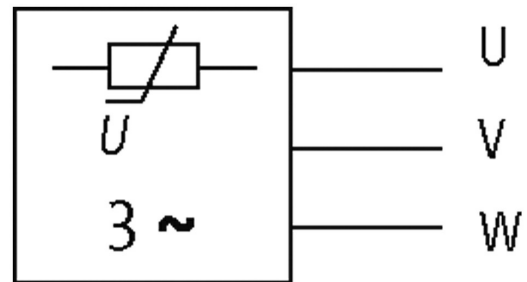

VDR

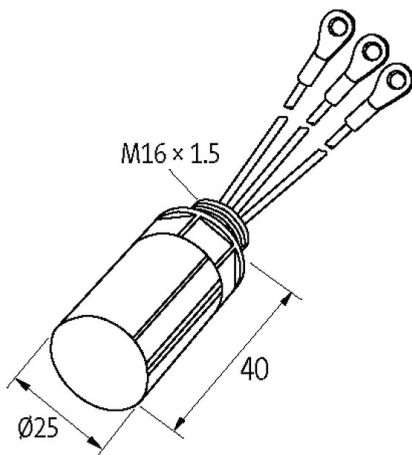

Product may differ from Image



Technical Data

Frequency	10...400 Hz
Input voltage	400...400 V AC
Material	Flame retardant plastic acc. to (UL 94)
Ring terminals	isolated M6
Potting compound	2-component epoxy

General data

Mounting method	on motor terminal box with plug connector
Temperature range	-20...+60 °C
Connection	approx. 100 mm, single cores 0.5 mm ²
Dimensions H×W×D	25×25×40 mm

Commercial data

country of origin	CZ
customs tariff number	85363010
EAN	4048879018937
eClass	27371013
Packaging unit	1.000