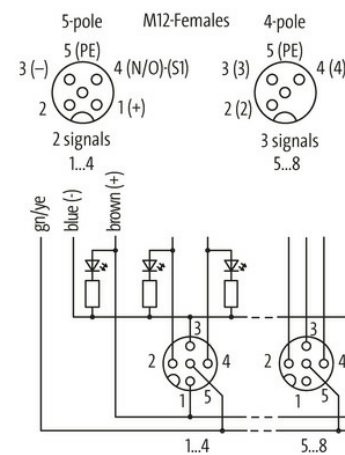
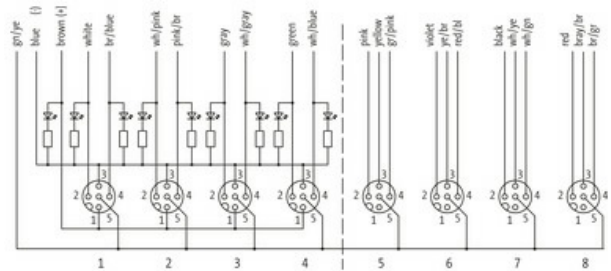
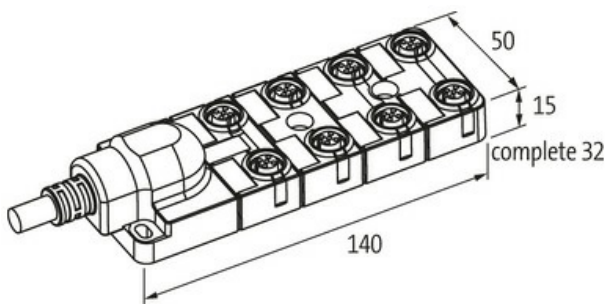
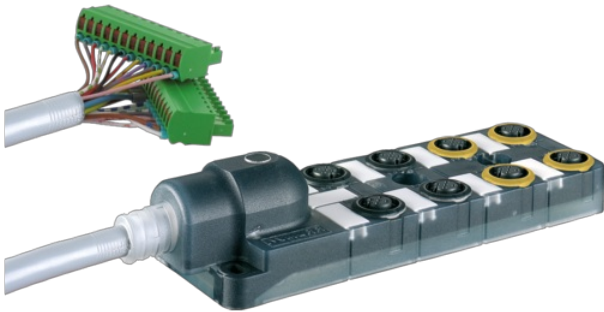

EXACT12 SAFETY, FIX. CABLE, P1-4 M12 5POLE LED,

P5-8 M12 4/3-pol 1:1 no LED, 5m PUR/PVC

PUR/PVC

5.0 m

[Link to Product](#)**Illustration**

Product may differ from Image

**Technical Data**

Operating voltage	24 V DC
Operating current per contact	max. 4 A
Locking of ports	Screw thread (M12×1 mm)
Protection	IP65/IP67
Housing	Plastic, flame retardant

General data

Temperature range	-20...+60 °C, depending on cable quality
-------------------	--

Cables

No./diameter of wires	20× 0.34 + 3× 0.75 mm ²
Wire isolation	PVC
C-track properties	2 Mio.

Outer Ø	10.0 mm ±5%
Cable number	407
Jacket Color	gray
Temperature range (fixed)	-30...+80 °C
Temperature range (mobile)	-5...+60 °C
Bend radius (fixed)	10× outer Ø
Bend radius (moving)	12× outer Ø
Material (jacket)	PUR/PVC (UL/CSA)

Contact Layout

PIN 1	(+) port 1...4
PIN 2	(NC)/(S2) port 1...4; (S1) port 5...8
PIN 3	(-) port 1...4; (S2) port 5...8
PIN 4	(NO)/(S1) port 1...4; (S3) port 5...8
PIN 5	(Earth)
LED (green): Power / LED (yellow): (S1) / LED (white): Signal (S2) port 1...4	

Commercial data

country of origin	DE
customs tariff number	85444290
EAN	4048879053563
eClass	27143423
Packaging unit	1.000