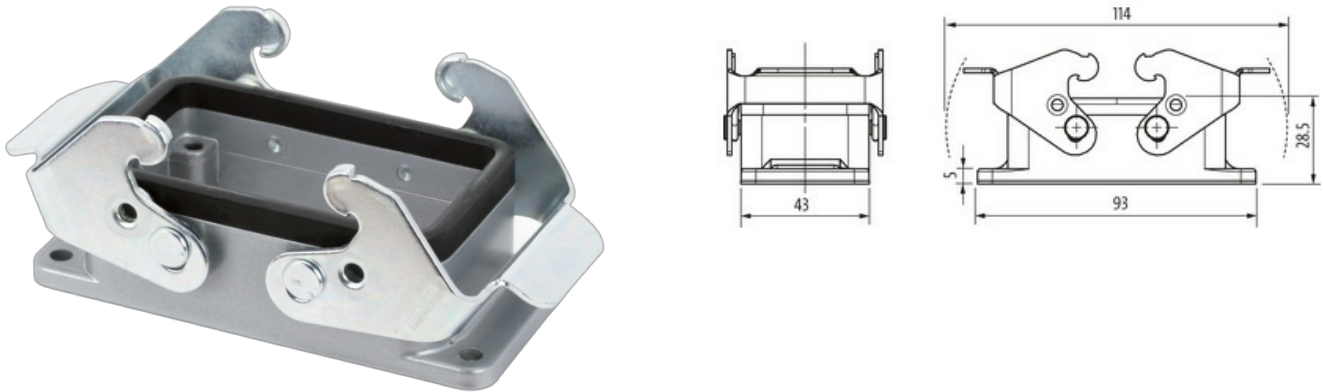

B10 Bulkhead mounted h., IP65

Double locking lever m.

B10
Bulkhead mounted housing
Double locking lever
IP65

Technical data will be only guaranteed with Murrelektronik components.

[Link to Product](#)**Illustration**

Product may differ from Image

Technical Data

Mating cycles	min. 500
Locking of ports	Double locking lever
Protection (housing)	IP65 inserted and tightened (EN 60529)

General data

Material (gasket)	NBR
Temperature range	-40...+100 °C
Material (housing)	Aluminum die-cast
Housing type	Bulkhead mounted housing
Size	B10
Locking material	Steel (galvanized)
Climatic category	40/100/21 (EN 60068-1)
Material (housing surface)	powder-coated
Dimensions H×W×D	28.5×43×93 mm

Commercial data

country of origin	CZ
customs tariff number	85389099
EAN	4048879644945
eClass	27143424
Packaging unit	1.000