

M12 male 0° / M12 female 0° A-cod. shielded

RADOX EM 104 4x0.5 shielded bk 7.5m

Male straight – female straight

M12 – M12, 4-pole

shielded

with cable sleeves

Plastic housings with good resistance against chemicals and oils.

The resistance to aggressive media should be individually tested for your application. Further details on request.

Further cable lengths on request.

Link to Product

Illustration

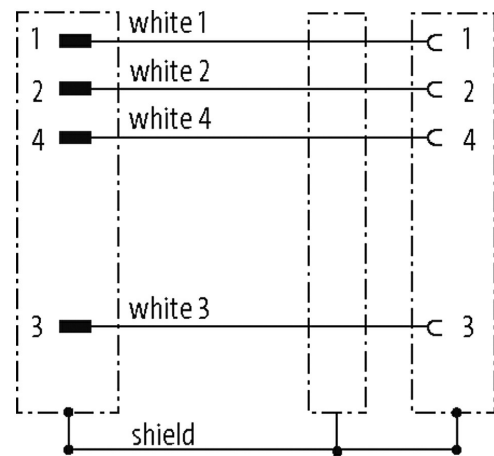
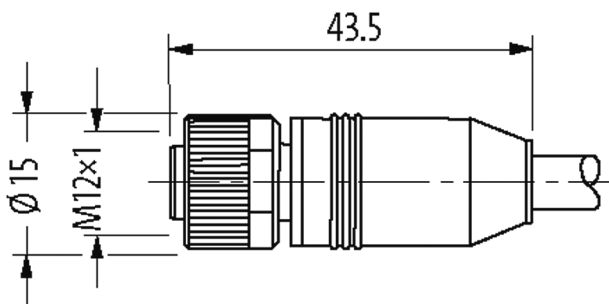

Male

Female

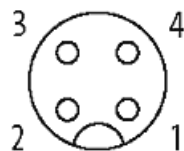
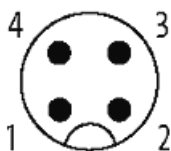

Product may differ from Image

Form

Form 40501

Technical Data

Operating voltage max. 60 V AC/DC

Rated surge voltage	1.5 kV
Operating current per contact	max. 4 A
No. of poles	4
Material group	IEC 60664-1, category I
Coding	A-coded
LED display	no
Locking of ports	Screw thread (M12×1 mm) recommended torque 0.6 Nm, self-securing
Compression gland	M12 (SW13)
Protection	IP65 and IP67 when plugged and screwed down (EN 60529)
Material	PUR
Locking material	Zinc die casting, matte nickel plated
suitable for corrugated tube (internal Ø)	without

General data

Standards	DIN EN 61076-2-101 (M12)
Mounting method	inserted, tightened
Pollution Degree	3
Temperature range	-25...+85 °C, depending on cable quality

Cables

Cable identification	R13
Approval (cable)	DIN EN 45545-2, CE conform
Cable weight [g/m]	67,10
Material (wire)	Cu wire, tin plated
Resistor (core)	max. 40.1 Ω/km (20 °C)
Single wire Ø (core)	0.18 mm
Construction (core)	19× 0.18 mm
Diameter (core)	4× 0.5 mm ²
AWG	similar to AWG 20
Material (wire isolation)	Radox EI 303
Wire-Ø incl. isolation	1.42 mm ±5%
Color/numbering of wires	wh (bk num)
Stranding combination	4 wires twisted
Shield	yes
Shield (Type)	Tinned wire mesh
Material (jacket)	Radox EM 104
Outer-Ø (jacket)	5.4 mm ±5%
Color (jacket)	black
Nominal voltage	600/1000 V AC
Test voltage	3500 V AC
Current load capacity	according to DIN VDE 0298-4
Temperature range (fixed)	-50...+120 °C
Bend radius (fixed)	3× outer-Ø
Bend radius (moving)	4× outer-Ø
Jacket Color	black

Commercial data

country of origin	DE
customs tariff number	85444290
EAN	4048879691208
eClass	27279218
Packaging unit	1