

M12 female 90° A-cod. with cable LED

RADOX EM 104 4x0.5 bk 10m

Female 90°

M12, 4-pole

3× LED (PNP)

with cable sleeves

Plastic housings with good resistance against chemicals and oils.

The resistance to aggressive media should be individually tested for your application. Further details on request.

Further cable lengths on request.

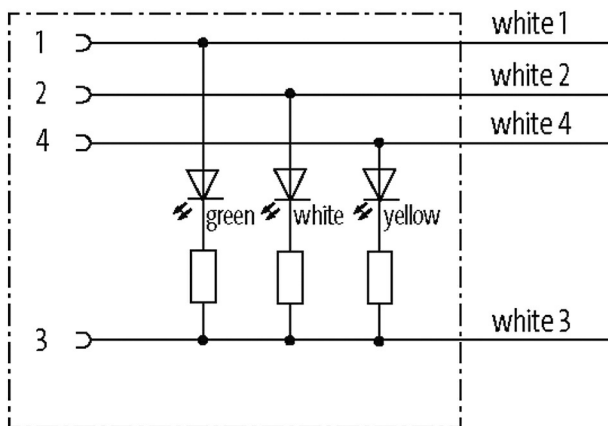
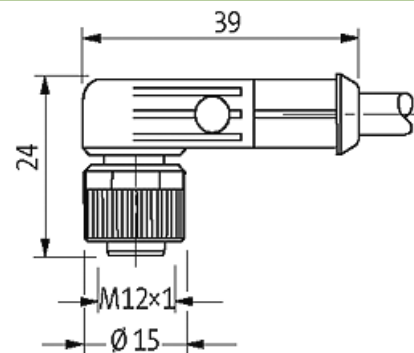
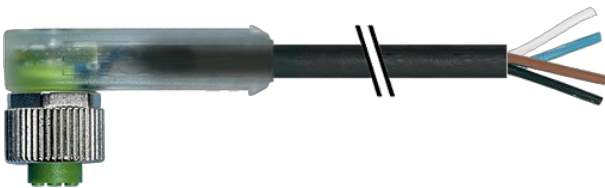
Link to Product**Illustration**

Female



Product may differ from Image

Form

Form 12421

Technical DataOperating voltage 24 V DC $\pm 25\%$

Operating current per contact max. 4 A

Rated surge voltage 0.8 kV

No. of poles 4

Material group IEC 60664-1, category I

Coding A-coded

LED display LED (green): Power / LED (yellow): (S1) / LED (white): Signal (S2)

Locking of ports Screw thread (M12x1 mm) recommended torque 0.6 Nm, self-securing

Compression gland M12 (SW13)

Locking material	Zinc die casting, matte nickel plated
Material	PUR
suitable for corrugated tube (internal Ø)	10 mm

General data

Standards	DIN EN 61076-2-101 (M12)
Mounting method	inserted, tightened
Pollution Degree	3
Stripping length (jacket)	40 mm
Temperature range	-25...+85 °C, depending on cable quality

Cables

Cable identification	R03
Approval (cable)	DIN EN 45545-2, CE conform
Cable weight [g/m]	62,70
Material (wire)	Cu wire, tin plated
Resistor (core)	max. 40.1 Ω/km (20 °C)
Single wire Ø (core)	0.18 mm
Construction (core)	19× 0.18 mm
Diameter (core)	4× 0.5 mm ²
AWG	similar to AWG 20
Material (wire isolation)	Radox EI 303
Wire-Ø incl. isolation	1.42 mm ±5%
Color/numbering of wires	wh (bk num)
Stranding combination	4 wires twisted
Shield	no
Material (jacket)	Radox EM 104
Outer-Ø (jacket)	5.0 mm ±5%
Color (jacket)	black
Nominal voltage	600/1000 V AC
Test voltage	3500 V AC
Current load capacity	according to DIN VDE 0298-4
Temperature range (fixed)	-50...+120 °C
Temperature range (mobile)	-25...+90 °C
Bend radius (fixed)	3× outer-Ø
Bend radius (moving)	4× outer-Ø
Jacket Color	black

Commercial data

country of origin	DE
customs tariff number	85444290
EAN	4048879670692
eClass	27279218
Packaging unit	1