

M12 male 90° / M12 male 90° X-cod. shielded

PUR 4x2xAWG26 shielded gn UL/CSA 11m

Ethernet CAT6A
 Male 90° – male 90°
 M12 – M12, 8-pole
 X-coded
 shielded

Transmission properties with channel transmission up to 50 m

Further cable lengths on request.

Plastic housings with good resistance against chemicals and oils.

The resistance to aggressive media should be individually tested for your application. Further details on request.

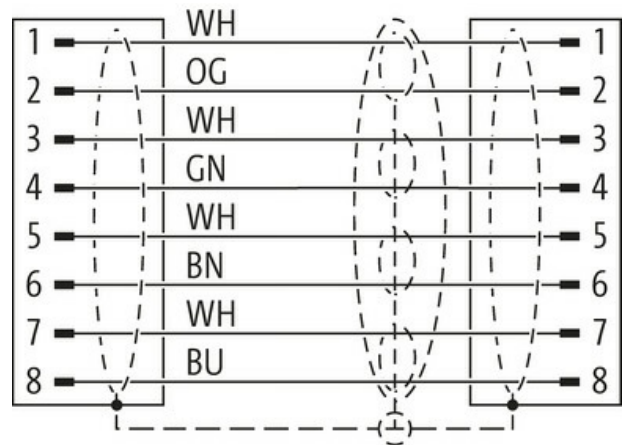
[Link to Product](#)**Illustration**

Male

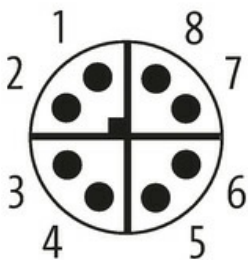

Male

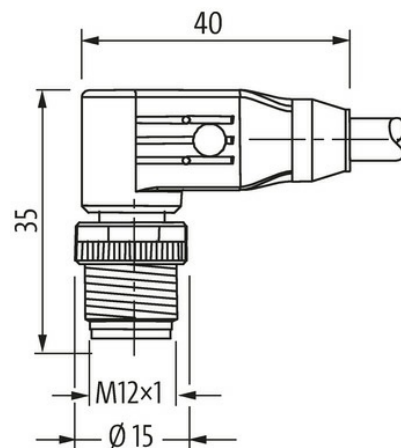
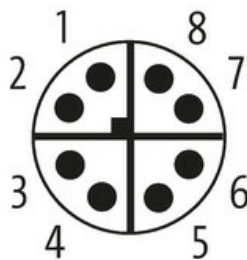

Product may differ from Image

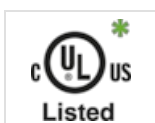

* only for products with UL/CSA approved cable

Form

Form

51021

Technical Data

The information in this brochure has been compiled with the utmost care.

Liability for the correctness completeness and topicality of the information is restricted to gross negligence. Version: 03/22

Murrelektronik Ltd. | 5 Albion Street, Pendlebury Industrial Estate, Swinton | Manchester M27 4FG | Fon +44 161 728 3133 | Fax +44 161 728 3130 | shop@murrelektronik.co.uk | shop.murrelektronik.co.uk

Operating voltage	max. 50 V AC/60 V DC
Operating voltage (only UL listed)	max. 30 V AC/DC
Rated surge voltage	1.5 kV
Operating current per contact	max. 0.5 A
Transfer parameters	CAT6, Class EA (ISO/IEC 11801:2002), (EN 50173-1)
Transfer rate	10 Gbit/s
Coding	X-coded
Locking of ports	Screw thread (M12×1 mm) recommended torque 0.6 Nm, self-securing
Protection	IP65 and IP67 when plugged and screwed down (EN 60529)
Material	PUR
Locking material	Zinc die casting, matte nickel plated

General data

Standards	DIN EN 61076-2-109 (M12)
Temperature range	-25...+85 °C, depending on cable quality

Cables

Cable identification	790
Approval (cable)	cURus (AWM-Style 20549/11635); CE conform
Cable weight [g/m]	52,8 g
Material (wire)	Cu wire, bare
Resistor (core)	max. 143 Ω/km (20 °C)
Single wire Ø (core)	0.16 mm
Diameter (core)	4× 2× AWG26/7
Material (wire isolation)	PE
Wire-Ø incl. isolation	1.05 mm ±5%
Color/numbering of wires	(WH, OR), (WH, BU), (WH, BN), (WH, GN)
Shield	yes
optical shield cover	approx. 65%
Material (jacket)	PUR
Outer-Ø (jacket)	6.4 mm ±5%
Color (jacket)	green
chemical resistance	Oil resistance according to IEC 60811-2-1, ASTM IRM 901, ICEA S-82-552 Std.
Nominal voltage	125 V AC
Test voltage	1500 V (wire/wire); 1000 V (wire/shield)
Temperature range (fixed)	-40...+80 °C
Temperature range (mobile)	-30...+70 °C
Bend radius (fixed)	8× outer Ø
Bend radius (moving)	10× outer Ø

Commercial data

country of origin	DE
customs tariff number	85444290
EAN	4048879841979
eClass	27061801
Packaging unit	1.000