

M12 female recept. Y-cod. shielded rear

PUR AWG20/26 shielded bk UL/CSA+drag ch. 3m

Ethernet CAT5

Flange female

Good chemical and oil resistance (oil resistance does not apply to use with PVC cable)

M12, 8-pole

Y-coded

shielded

Transmission properties with channel transmission up to 50 m

Further cable lengths on request.

The resistance to aggressive media should be individually tested for your application. Further details on request.

[Link to Product](#)

Illustration

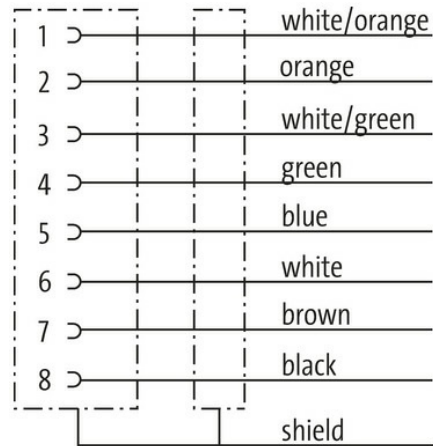

Female

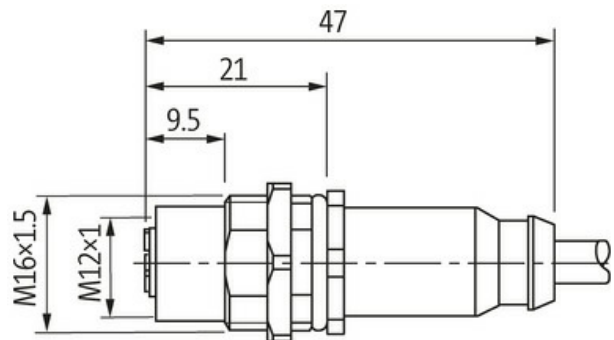
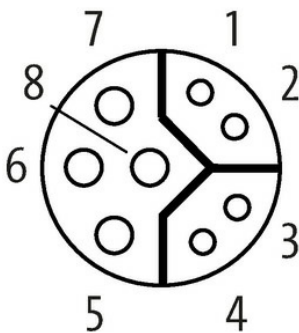

Product may differ from Image



Form

Form

15671

Technical Data	
Operating voltage	max. 50 V AC/DC
Operating voltage (only UL listed)	30 V AC/DC
Rated surge voltage	0.8 kV
Operating current per contact	0.5 A (Data), 6 A (Power)max. 0.5 A/max. 6 A
No. of poles	8
Transfer parameters	CAT5, Class D (ISO/IEC 11801:2002), (EN 50173-1)
Transfer rate	up to 100 Mbit/s full duplex
Material group	IEC 60664-1, category I
Coding	Y-coded
Locking of ports	Screw thread (M12×1 mm) recommended torque 0.6 Nm, self-securing
Compression gland	M12 (SW14)
Protection	IP67 inserted and tightened (EN 60529)
Protection NEMA	3, 4, 6P (UL 50E)
Locking material	Brass, nickel plated
General data	
Pollution Degree	3
Temperature range	-25...+85 °C, depending on cable quality
Cables	
Cable identification	805
Approval (cable)	cURus (AWM-Style 20549/10493); CE conform
Cable weight [g/m]	107,8 g
Material (wire isolation)	PP
Material property (wire isolation)	CFC-, halogen-, cadmium-, silicone- and lead-free
Shore hardness (wire isolation)	55 ±5 D
Color/numbering of wires	(bk, br, wh, bl), (whor, or, whgn, gn)
Shield	yes
optical shield cover	min. 85%
Material (jacket)	PUR
Material property (jacket)	CFC-, halogen-, cadmium-, silicone- and lead-free, matt, low-adhesion, machine easy to process, abrasion-resistant, hydrolysis and microbial resistant
Shore hardness (jacket)	90 ±5 A
Outer-Ø (jacket)	8.1 mm ±5%
Color (jacket)	black
chemical resistance	Oil resistance according to IEC 60811-2-1, ASTM IRM 901, ICEA S-82-552 Std.
thermal resistance	flame-retardant according to UL 1581 section 1090, section 1100 (FT2), IEC 60332-1-2 Std.
Nominal voltage	60 V AC
Test voltage	1000 V AC
Current load capacity	to DIN VDE 0298-4
Temperature range (fixed)	-40...+80 °C
Temperature range (mobile)	-30...+70 °C
Bend radius (fixed)	5× outer Ø
Bend radius (moving)	10× outer Ø
No. of bending cycles (C-track)	max. 2 Mio. (25 °C)
Travel speed (C-track)	max. 3.3 m/s
Acceleration (C-track)	max. 5 m/s ²
Torsion stress	±30°/m
No. of torsion cycles	max. 2 Mio. (25 °C)
Torsion speed	35 cycles/min
Commercial data	
country of origin	DE
customs tariff number	85444290
EAN	4048879536363

eClass	27279220
Packaging unit	1.000
