

M12 male 0° / M12 female 0° B-cod. shielded

PVC 1x2xAWG24 shielded vt UL/CSA 15m

PROFIBUS

Male straight – female straight

M12, 4-pole – M12, 2-pole

B-coded

shielded

Plastic housings with good resistance against chemicals and oils.

The resistance to aggressive media should be individually tested for your application. Further details on request.

Further cable lengths on request.

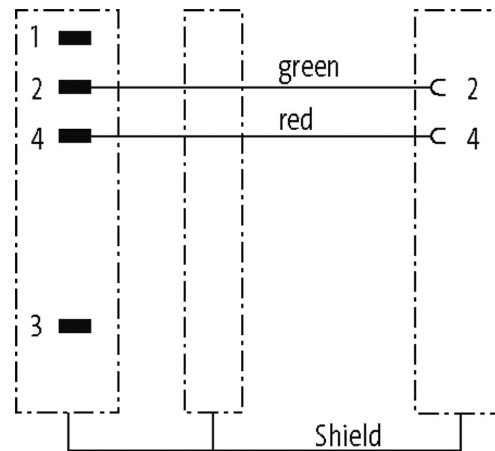
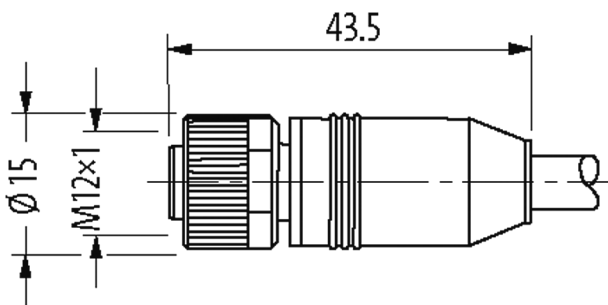
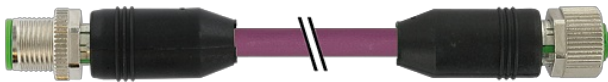
[Link to Product](#)**Illustration**

Male

Female

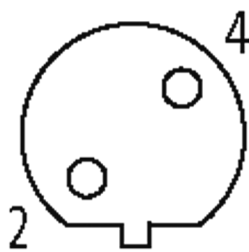

Product may differ from Image



* only for products with UL/CSA approved cable

Form	
Form	44001
Technical Data	
Operating voltage	max. 60 V AC/DC
Operating voltage (only UL listed)	max. 30 V AC/DC
Rated surge voltage	1.5 kV
Operating current per contact	max. 4 A
Material group	IEC 60664-1, category I
Coding	B-coded
Locking of ports	Screw thread (M12×1 mm) recommended torque 0.6 Nm, self-securing
Compression gland	M12 (SW13)
Protection	IP65, IP66K, IP67 inserted and tightened (EN 60529)
Locking material	Zinc die casting, matte nickel plated
Material	PUR
suitable for corrugated tube (internal Ø)	without
General data	
Standards	DIN EN 61076-2-101 (M12)
Mounting method	inserted, tightened
Pollution Degree	3
Temperature range	-25...+85 °C, depending on cable quality
Cables	
No./diameter of wires	1 × 2 × 0.25 mm ²
Wire isolation	PE (rd, gn)
C-track properties	2 Mio.
Material (jacket)	PVC (UL)
Outer Ø	7.8 mm ±5%
Bend radius (moving)	12× outer Ø
Temperature range (fixed)	-25...+70 °C
Temperature range (mobile)	-20...+50 °C
Cable identification	850
Cable weight [g/m]	75,90
Material (wire)	Cu wire, bare
Resistor (core)	max. 68 Ω/km (20 °C)
Single wire Ø (core)	0.13 mm
Construction (core)	19× 0.13 mm
Diameter (core)	1 × 2 × 0.25 mm ²
AWG	similar to AWG 24
Material (wire isolation)	PE
Wire-Ø incl. isolation	2.55 mm ±5%
Color/numbering of wires	rd, gn
Shield	yes
optical shield cover	min. 70%
Material (jacket)	PVC
Outer-Ø (jacket)	7.8 mm ±5%
Color (jacket)	violet
Nominal voltage	30 V AC
Test voltage	1.5 kV
Temperature range (fixed)	-25...+70 °C

The information in this brochure has been compiled with the utmost care.

Liability for the correctness completeness and topicality of the information is restricted to gross negligence. Version: 03/22

Temperature range (mobile)	-20...+50 °C
Bend radius (fixed)	7.5× outer Ø
Bend radius (moving)	12× outer Ø
No. of bending cycles (C-track)	max. 2 Mio. (25 °C)
Traversing distance (C-track)	max. 5 m (horizontal)
Travel speed (C-track)	max. 3 m/s
Acceleration (C-track)	max. 5 m/s ²
Jacket Color	violet

Commercial data

country of origin	DE
customs tariff number	85444290
EAN	4048879439343
eClass	27061801
Packaging unit	1