

MQ15-X-Power female 90°left, with cable

PVC 6x1,5 bk UL/CSA 5,0m

Female 90°

MQ15, 6-pole

without cable sleeves

Plastic housings with good resistance against chemicals and oils.

The resistance to aggressive media should be individually tested for your application. Further details on request.

Further cable lengths on request.

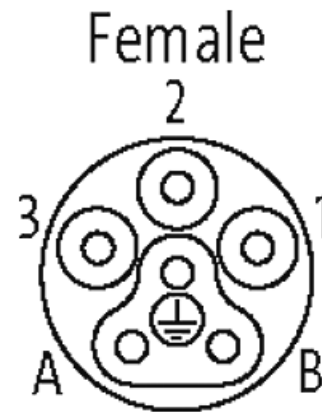
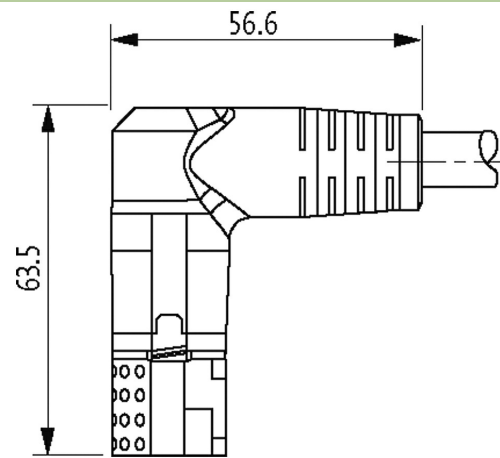
[Link to Product](#)**Illustration**

Product may differ from Image

Form

Form P8132

Technical Data

Operating voltage	max. 600 V AC (Power); max. 63 V AC/DC (Signal)
Rated surge voltage	4.0 kV
Operating current per contact	max. 13 A (Power); max. 10 A (Signal)
Material group	IEC 60664-1, category I
No. of poles	6
Configuration	fully used
LED display	no

The information in this brochure has been compiled with the utmost care.

Liability for the correctness completeness and topicality of the information is restricted to gross negligence. Version: 03/22

Locking of ports	Quick connection, 1/4 turn
Protection	IP67 inserted and tightened (EN 60529)
Material	Flame retardant plastic acc. to (UL 94)
Mating cycles	≥ 500

General data

Mounting method	inserted, tightened
Material (contact carrier)	PA
Material (contact)	Copper alloy
Material (contact surface)	Ag
Pollution Degree	3
Stripping length (jacket)	30 mm
Temperature range	-25...+80 °C, depending on cable quality

Cables

Cable number	P24
No./diameter of wires	6× 1.5 mm ²
Wire isolation	PP (bk num, gnye)
Jacket Color	black
Material (jacket)	PVC (UL)
Outer Ø	9.0 mm ±5%
Bend radius (moving)	15× outer Ø
Temperature range (fixed)	-20...+80 °C
Temperature range (mobile)	-5...+80 °C
Cable identification	P24
Material (wire)	Cu wire, bare
Resistor (core)	max. 13.3 Ω/km (20 °C)
Color/numbering of wires	bk numbered, gnye longitudinally striped
Shield	no
Material (jacket)	PVC
Outer-Ø (jacket)	9.0 mm ±5%
Color (jacket)	black
thermal resistance	flame retardant
Nominal voltage	1000 V AC
Test voltage	4000 V
Temperature range (fixed)	-20...+80 °C
Bend radius (fixed)	5× outer Ø

Commercial data

country of origin	DE
customs tariff number	85444290
EAN	4048879705950
eClass	27279218
Packaging unit	1