

Mini (7/8) 4 pole, Male (Ext.) 90° w/ Cable

PUR 4x1.5 (4x16AWG) bk UL/CSA

Male 90°

7/8"

4-pole

Power cable

USA

without cable sleeves

Further cable lengths on request.

Plastic housings with good resistance against chemicals and oils.

The resistance to aggressive media should be individually tested for your application. Further details on request.

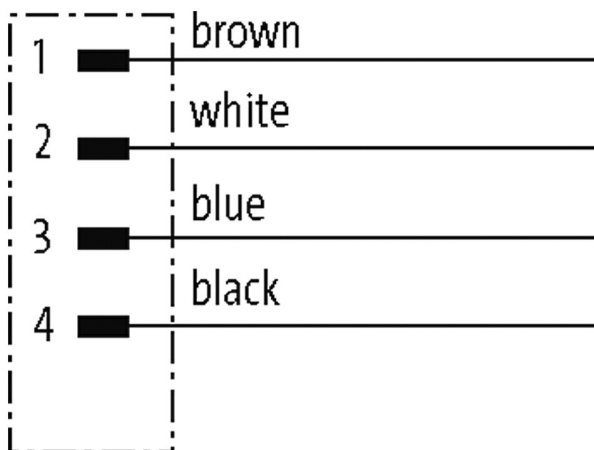
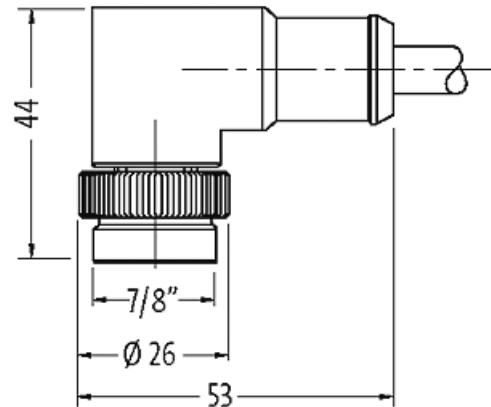
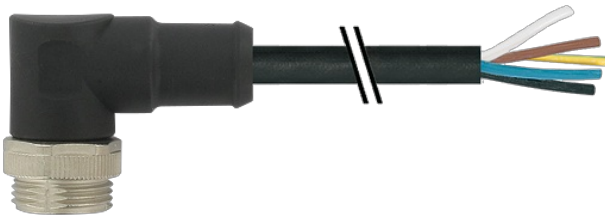
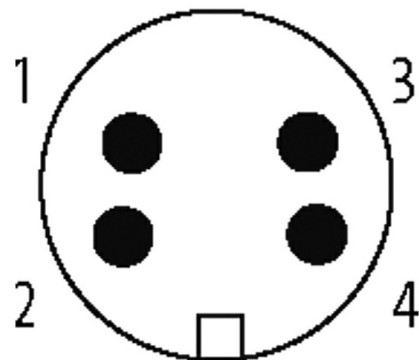
Link to Product**Illustration****Male**

Product may differ from Image

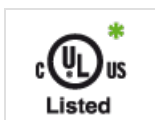

* only for products with UL/CSA approved cable

Form

Form

A4011

Technical Data

Operating voltage	max. 600 V AC/DC
Rated surge voltage	4.0 kV
Operating current per contact	max. 9 A
No. of poles	4
LED display	no
Locking of ports	Screw thread 7/8" (recommended torque 1.5 Nm) self-securing
Compression gland	7/8" (SW24)
Protection	IP68 inserted and tightened (EN 60529)
Locking material	Zinc die casting, matte nickel plated
Material	PUR

General data

Mounting method	inserted, tightened
Pollution Degree	3
Temperature range	-25...+80 °C, depending on cable quality

Cables

Cable number	UMC
No./diameter of wires	4× 1.5 mm ²
Construction (core)	2.3 mm ±5%
Wire isolation	TPM (br, wh, bl, bk)
C-track properties	5 Mio.
Jacket Color	black
Material (jacket)	PUR (UL/CSA)
Outer Ø	8.0 mm ±5%
Bend radius (fixed)	7.5× outer Ø
Bend radius (moving)	10× outer Ø
Temperature range (fixed)	-50...+80 °C
Temperature range (mobile)	-20...+80 °C

Commercial data

country of origin	DE
customs tariff number	85444290
EAN	4048879648295
eClass	27279218
Packaging unit	1