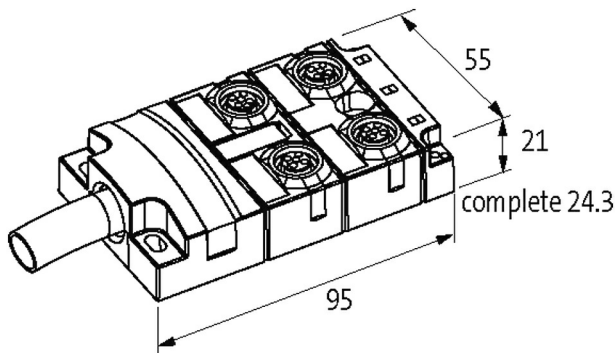

MVP-METALL, 4XM12, 5POLE, PRE-WIRED CABLE

5.0m PUR 8x0,34+3X0.75, UL/CSA

5.0 m

Replaces identical product (Art.No. 27487)

[Link to Product](#)**Illustration**

Product may differ from Image

**Technical Data**

Operating voltage	max. 125 V AC/DC
Operating current per contact	max. 4 A
Locking of ports	Screw thread (M12x1 mm)
Protection	IP65, IP67, IP68
Housing	Zinc die casting, matte nickel plated

General data

Temperature range	-20...+90 °C, depending on cable quality
-------------------	--

Cables

No./diameter of wires	8 x 0.34 + 3 x 0.75 mm ²
Wire isolation	TPE (grpk, wh, rdbl, gn, whgn, ye, brgn, gr, br, bl, gnye)
C-track properties	5 Mio.
Outer Ø	9.3 mm ±5%

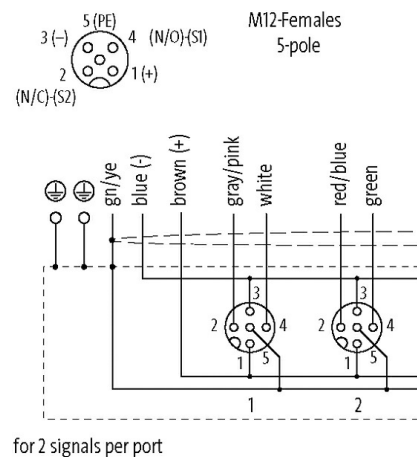
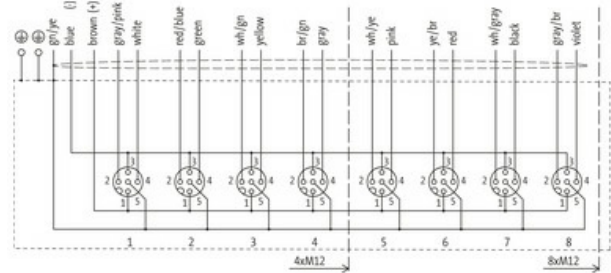

Cable number	373
Shield	yes
Color (jacket)	gray
Jacket Color	gray
Temperature range (fixed)	-40...+90 °C
Temperature range (mobile)	-40...+90 °C
Bend radius (fixed)	10× outer Ø
Bend radius (moving)	12× outer Ø
Material (jacket)	PUR (UL/CSA)

Contact Layout

PIN 1	(+)
PIN 2	(NC)/(S2)
PIN 3	(-)
PIN 4	(NO)/(S1)
PIN 5	(Earth)

Commercial data

country of origin	CZ
customs tariff number	85444290
EAN	4048879351720
eClass	27279219
Packaging unit	1.000