

M12 Steel male 90° / M12 Steel female 90° A-cod.

PVC 4x0.34 gy UL/CSA 5m

F&B-Steel

Male 90° – female 90°

M12 – M12, 4-pole

Further cable lengths on request.

[Link to Product](#)

Illustration

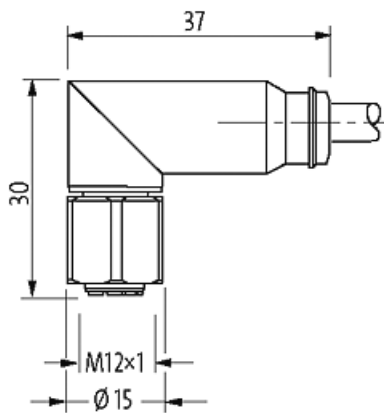
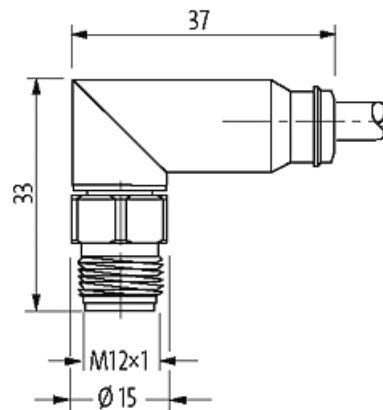
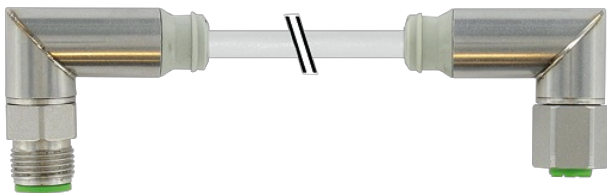

1	brown (+)	C 1
2	white (N/C)	C 2
4	black (N/O)	C 4
3	blue (-)	C 3

Male

Female

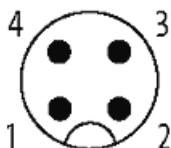

Product may differ from Image



* only for products with UL/CSA approved cable

Form

Form 40261

Technical Data

Operating voltage	max. 32 V AC/DC
Operating current per contact	max. 4 A
Locking of ports	Screw thread (M12×1 mm) recommended torque 0.6 Nm, self-securing
Protection	IP68, IP69K inserted and tightened (EN 60529)
Locking material	Stainless steel 1.4404 (V4A)

General data

Temperature range	-40...+85 °C, depending on cable quality
-------------------	--

Cables

Cable identification	214
Cable Type	1 (PVC)
Approval (cable)	UL (AWM-Style 2464/1731), CSA
Cable weight [g/m]	40,70
Material (wire)	Cu wire, bare
Resistor (core)	max. 60 Ω/km (20 °C)
Single wire Ø (core)	0.15 mm
Construction (core)	19× 0.15 mm (multi-strand wire class 5)
Diameter (core)	4× 0.34 mm ²
AWG	similar to AWG 22
Material (wire isolation)	PVC
Material property (wire isolation)	CFC-, cadmium-, silicone- and lead-free
Shore hardness (wire isolation)	45 ±5 D
Wire-Ø incl. isolation	1.25 mm ±5%
Color/numbering of wires	br, bk, bl, wh
Stranding combination	4 wires twisted
Shield	no
Material (jacket)	PVC
Material property (jacket)	CFC-, cadmium-, silicone- and lead-free
Shore hardness (jacket)	85 ±5 A
Outer-Ø (jacket)	5.0 mm ±5%
Color (jacket)	gray
chemical resistance	good resistance to oil, gasoline and chemicals
thermal resistance	flame retardant UL 1581 VW1 / CSA FT1
Nominal voltage	UL 300 V AC
Test voltage	2000 V AC
Current load capacity	to DIN VDE 0298-4
Temperature range (fixed)	-30...+80 °C
Temperature range (mobile)	-5...+80 °C
Bend radius (fixed)	5× outer Ø
Bend radius (moving)	10× outer Ø
No./diameter of wires	4× 0.34 mm ²
Wire isolation	PVC (br, wh, bl, bk)
Jacket Color	gray
Material (jacket)	PVC (UL/CSA)
Outer Ø	5.0 mm ±5%
Bend radius (moving)	10× outer Ø
Temperature range (fixed)	-30...+80 °C
Temperature range (mobile)	-5...+80 °C

Commercial data

country of origin	CZ
customs tariff number	85444290

EAN	4048879580977
eClass	27279218
Packaging unit	1