

M8 male 0° / M8 female 0°

PUR 8x0.14 bk UL 5m

Male straight – female straight

M8, 8-pole

with cable sleeves

Plastic housings with good resistance against chemicals and oils.

The resistance to aggressive media should be individually tested for your application. Further details on request.

Further cable lengths on request.

[Link to Product](#)

Illustration



1	white	C 1
2	brown	C 2
3	green	C 3
4	yellow	C 4
5	gray	C 5
6	pink	C 6
7	blue	C 7
8	red	C 8

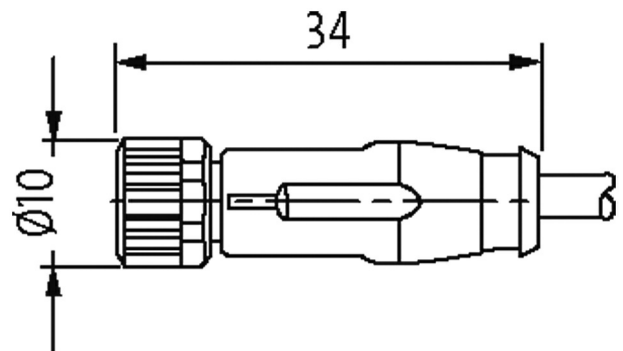
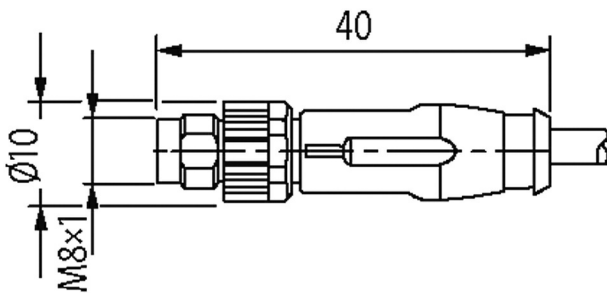

Male

Female

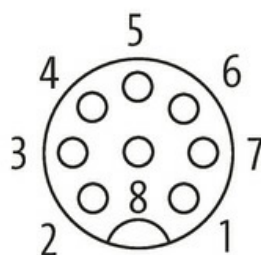
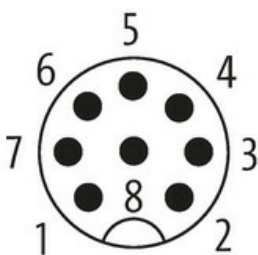

Product may differ from Image



Form	
Form	89341
Technical Data	
Operating voltage	max. 30 V AC/DC
Operating current per contact	max. 1.5 A
No. of poles	8
Coding	A-coded
Mating cycles	≥ 100
LED display	no
Locking of ports	Screw thread (M8×1 mm) recommended torque 0.4 Nm, self-securing
Compression gland	M8 (SW9)
Protection	IP67 inserted and tightened (EN 60529)
Material	TPU
Locking material	Zinc die casting, matte nickel plated
General data	
Mounting method	inserted, tightened
Material (contact)	Copper alloy
Material (contact surface)	Au
Material (gasket)	FKM
Pollution Degree	3/2
Temperature range	-30...+80 °C
Cables	
Cable identification	696
Material (wire)	Cu wire, bare
Resistor (core)	max. 78 Ω/km (20 °C)
Single wire Ø (core)	0.1 mm
Construction (core)	18× 0.1 mm (multi-strand wire class 6)
Diameter (core)	8× 0.14 mm ²
AWG	similar to AWG 14
Material (wire isolation)	PP
Wire-Ø incl. isolation	1.07 mm ±5%
Stranding combination	8 wires twisted around central filler
Shield	no
Material (jacket)	PUR
Outer-Ø (jacket)	5.5 mm ±5%
Color (jacket)	black
Jacket Color	black
Nominal voltage	300 V
Test voltage	3000 V AC
Temperature range (fixed)	-30...+80 °C
Temperature range (mobile)	-15...+80 °C
Bend radius (fixed)	6× outer Ø
No. of bending cycles (C-track)	max. 2 Mio. (25 °C)
Travel speed (C-track)	max. 5 m/s
Acceleration (C-track)	max. 10 m/s ²
Commercial data	
country of origin	CZ

customs tariff number	85444290
EAN	4048879744621
eClass	27279218
Packaging unit	1.000