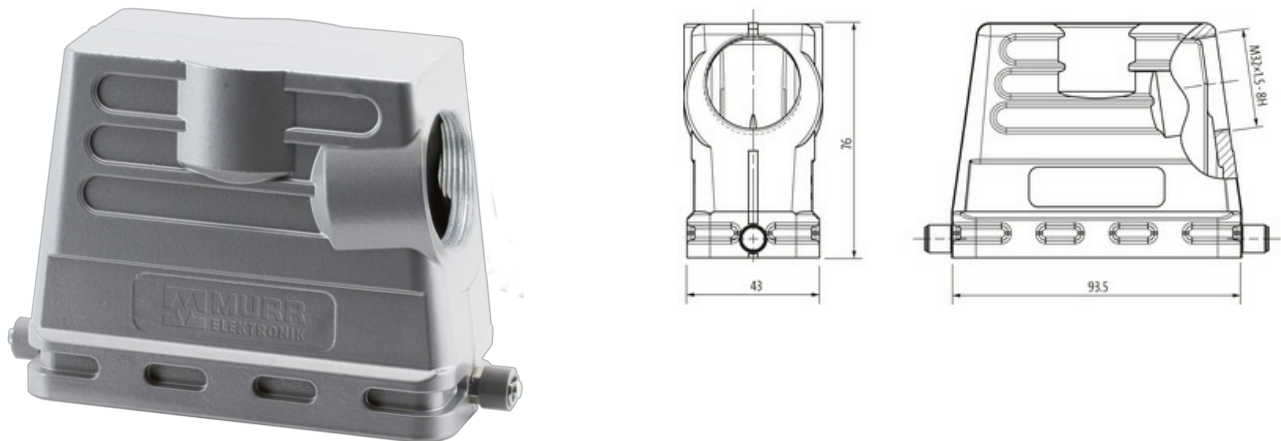

B16 Hood, high profile, IP65

Single locking lever, side entry M32

B16
Hood (high)
Single locking lever
IP65

Technical data will be only guaranteed with Murrelektronik components.

[Link to Product](#)**Illustration**

Product may differ from Image

Technical Data

Mating cycles	min. 500
Locking of ports	Single locking lever
Protection (housing)	IP65 inserted and tightened (EN 60529), with gland

General data

Temperature range	-40...+100 °C
Material (housing)	Aluminum die-cast
Housing type	Hood
Threaded hole	M32
Size	B16
Cable outlet	laterally
Locking material	Steel (galvanized)
Climatic category	40/100/21 (EN 60068-1)
Material (housing surface)	powder-coated
Dimensions H×W×D	76×43×93.5 mm

Commercial data

country of origin	CZ
customs tariff number	85389099
EAN	4048879646758
eClass	27143424
Packaging unit	1.000