

MTL 1-PHASE CONTROL AND ISOLATION TRANSFORMER

P: 63VA IN: 230/400VAC +/- 15VAC OUT: 2x115VAC

Single-phase - Control and Isolation Transformers

63 VA

Isolation class T 60/B

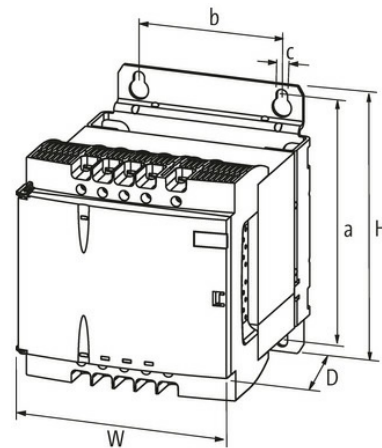
[Link to Product](#)**Illustration**

Product may differ from Image

**Technical Data**

LED display LED (green) for input voltage

General data

Standards	EN 61558-1, EN 61558-2-4, EN 62041 category 0
Mounting method	DIN-rail mountable TH35-15 (EN 60715) or for key-hole mounting
Temperature range	-20...+60 °C, no condensation
Test isolation voltage	4 kV (prim./sec.)
Drill hole Ø	5.5×9 mm
Fixing centers a×b×c	96×60×5.5 mm
Dimensions H×W×D	108×87×116 mm

Output

Output voltage	1× 230, 1× 115, 2× 115 V AC
Output rating	63 VA

Input

Input voltage	230/400 ±15 V AC
Inrush current	5.35 A (230 V AC); 3.09 A (400 V AC)
Short-circuit current	7.2 A (230 V AC); 4.16 A (400 V AC)
Input current	0.4 A (230 V AC); 0.23 A (400 V AC)
Frequency	50...60 Hz

Commercial data

country of origin	CZ
customs tariff number	85043180

EAN	4048879078214
eClass	27031302
Packaging unit	1.000