

Valve plug MJC 0° with cable LED

PVC 2x0.75 bk 3m

Female straight
10...30 V AC/DC
LED

Plastic housings with good resistance against chemicals and oils.

The resistance to aggressive media should be individually tested for your application. Further details on request.

Further cable lengths on request.

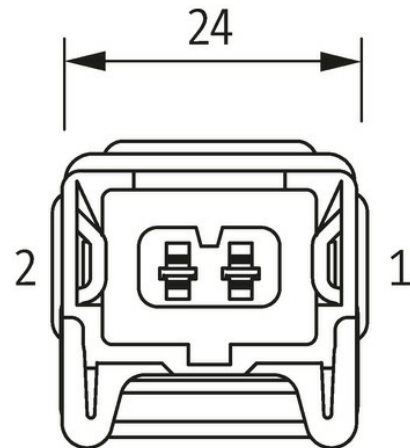
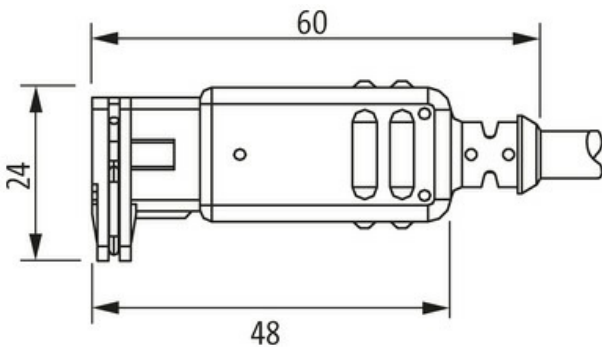
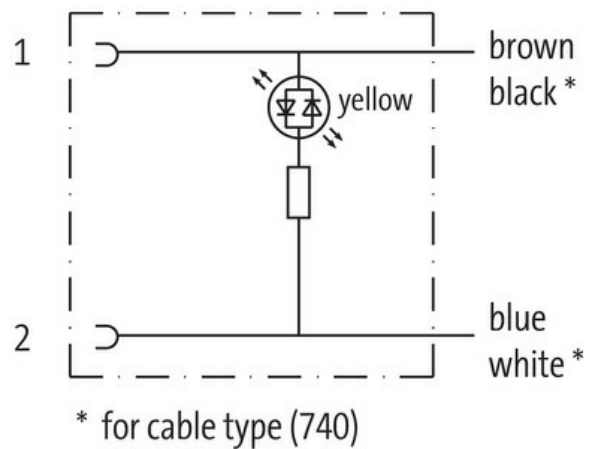
[Link to Product](#)**Illustration**

Product may differ from Image

Form

Form 70021

Technical Data

Operating voltage	10...30 V AC/DC
Rated surge voltage	0.8 kV
Operating current per contact	max. 4 A
Current consumption	approx. 12 mA
LED display	(yellow)

Protection	IP65 inserted and tightened (EN 60529)
Housing	Black plastic, flame retardant

General data

Temperature range	-25...+85 °C, depending on cable quality
-------------------	--

Cables

No./diameter of wires	2× 0.75 mm ²
Wire isolation	PVC (br, bl)
Outer Ø	5.2 mm ±5%
Cable identification	752
Cable number	752
Approval (cable)	CE
Cable weight [g/m]	50,6 g
Material (wire)	Cu wire, bare
Resistor (core)	max. 26 Ω/km (20 °C)
Single wire Ø (core)	0.2 mm
Construction (core)	24× 0.2 mm (multi-strand wire class 5)
Diameter (core)	2× 0.75 mm ²
AWG	similar to AWG 18
Material (wire isolation)	PVC
Material property (wire isolation)	CFC-, cadmium-, silicone- and lead-free
Shore hardness (wire isolation)	90 ±5 A
Wire-Ø incl. isolation	1.8 mm ±5%
Color/numbering of wires	br, bl
Stranding combination	2 wires twisted
Shield	no
Material (jacket)	PVC
Material property (jacket)	CFC-, cadmium-, silicone- and lead-free, matt, low-adhesion, machine easy to process, abrasion-resistant
Shore hardness (jacket)	80 ±5 A
Outer-Ø (jacket)	5.2 mm ±5%
Color (jacket)	black
Jacket Color	black
chemical resistance	good resistance to oil, gasoline and chemicals
thermal resistance	flame retardant
Nominal voltage	300/500 V AC
Test voltage	2000 V AC
Current load capacity	to DIN VDE 0298-4
Temperature range (fixed)	-30...+70 °C
Temperature range (fixed)	-30...+70 °C
Temperature range (mobile)	-5...+70 °C
Temperature range (mobile)	-5...+70 °C
Bend radius (fixed)	10× outer Ø
Bend radius (moving)	15× outer Ø
Bend radius (moving)	15× outer Ø
Material (jacket)	PVC

Commercial data

country of origin	DE
customs tariff number	85444290
EAN	4048879135511
eClass	27279218
Packaging unit	1.000