

M12 male 90° A-cod. / MSUD valve plug A-18mm

PUR 3x0.75 ye UL/CSA 3m

Form A (18 mm) – M12, male 90°

24 V AC $\pm 20\%$ / DC $\pm 25\%$

LED and suppression

Bridged PE

Art-No. 7005 - M12 Lite - (plastic hexagonal screw) on request

Further cable lengths on request.

Plastic housings with good resistance against chemicals and oils.

The resistance to aggressive media should be individually tested for your application. Further details on request.

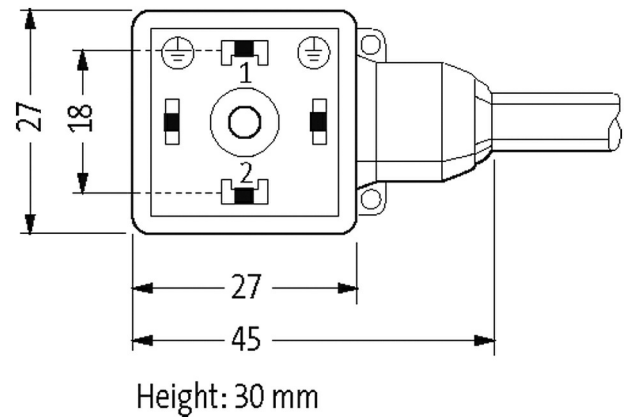
[Link to Product](#)**Illustration**

Female



Male



Product may differ from Image

**Form**

Form 40901

Technical Data

Operating voltage	24 V AC $\pm 20\%$ / DC $\pm 25\%$
Rated surge voltage	0.8 kV
Operating current per contact	max. 4 A
Current consumption	approx. 15 mA
Material group	IEC 60664-1, category I
Switch off peak	max. 55 V
Switch off delay time	max. 20 ms
Coding	A-coded
LED display	yellow
Locking of ports	M3/M12 \times 1 mm (recommended torque 0.4/0.6 Nm)
Compression gland	M12 (SW13)
Protection	IP67 inserted and tightened (EN 60529)
Locking material	Zinc die casting, matte nickel plated
Material	MSUD (PBT); M12 (PUR)
suitable for corrugated tube (internal \varnothing)	10 mm
Housing	Black plastic (gray on request)
Additional suppressor	Diode/Z-Diode

General data

Pollution Degree	3
Temperature range	-25...+85 °C, depending on cable quality
Material (gasket)	PUR

Cables

No./diameter of wires	3 \times 0.75 mm ²
Wire isolation	PVC (bk num, gnye)
C-track properties	2 Mio.
Material (jacket)	PUR/PVC (UL/CSA)
Outer \varnothing	5.9 mm $\pm 5\%$
Bend radius (moving)	15 \times outer \varnothing
Temperature range (fixed)	-30...+80 °C
Temperature range (mobile)	-5...+80 °C
Cable identification	026
Cable Type	2 (PUR/PVC)
Approval (cable)	UL (AWM-Style 20549/1731), CSA; CE conform
Cable weight [g/m]	55,00
Material (wire)	Cu wire, bare
Resistor (core)	max. 26 Ω /km (20 °C)
Single wire \varnothing (core)	0.15 mm
Construction (core)	42 \times 0.15 mm (multi-strand wire class 6)
Diameter (core)	3 \times 0.75 mm ²
AWG	similar to AWG 18
Material (wire isolation)	PVC
Material property (wire isolation)	CFC-, cadmium-, silicone- and lead-free
Shore hardness (wire isolation)	43 \pm 5 D
Wire- \varnothing incl. isolation	1.8 mm $\pm 5\%$
Color/numbering of wires	bk numbered, gnye longitudinally striped

The information in this brochure has been compiled with the utmost care.

Liability for the correctness completeness and topicality of the information is restricted to gross negligence. Version: 03/22

Stranding combination	3 wires twisted
Shield	no
Material (jacket)	PUR/PVC
Material property (jacket)	CFC-, halogen-, cadmium-, silicone- and lead-free, matt, low-adhesion, machine easy to process, abrasion-resistant, hydrolysis and microbial resistant
Shore hardness (jacket)	80 ±5 A (PVC-under jacket); 85 ±5 A (PUR-jacket)
Outer-Ø (jacket)	5.9 mm ±5%
Color (jacket)	yellow
chemical resistance	good resistance to oil, gasoline and chemicals
Nominal voltage	UL 300 V AC
Test voltage	2000 V AC
Current load capacity	to DIN VDE 0298-4
Temperature range (fixed)	-30...+80 °C
Temperature range (mobile)	-5...+80 °C
Bend radius (fixed)	10× outer Ø
Bend radius (moving)	15× outer Ø
No. of bending cycles (C-track)	max. 2 Mio. (25 °C)
Traversing distance (C-track)	max. 5 m (horizontal)
Travel speed (C-track)	max. 3.3 m/s
Acceleration (C-track)	max. 5 m/s ²
Jacket Color	yellow

Commercial data

country of origin	CZ
customs tariff number	85444290
EAN	4048879428712
eClass	27279218
Packaging unit	1